

**vivitek**<sup>®</sup> User Manual  
Vivid Color, Vivid Life

DX864 / DW866 series

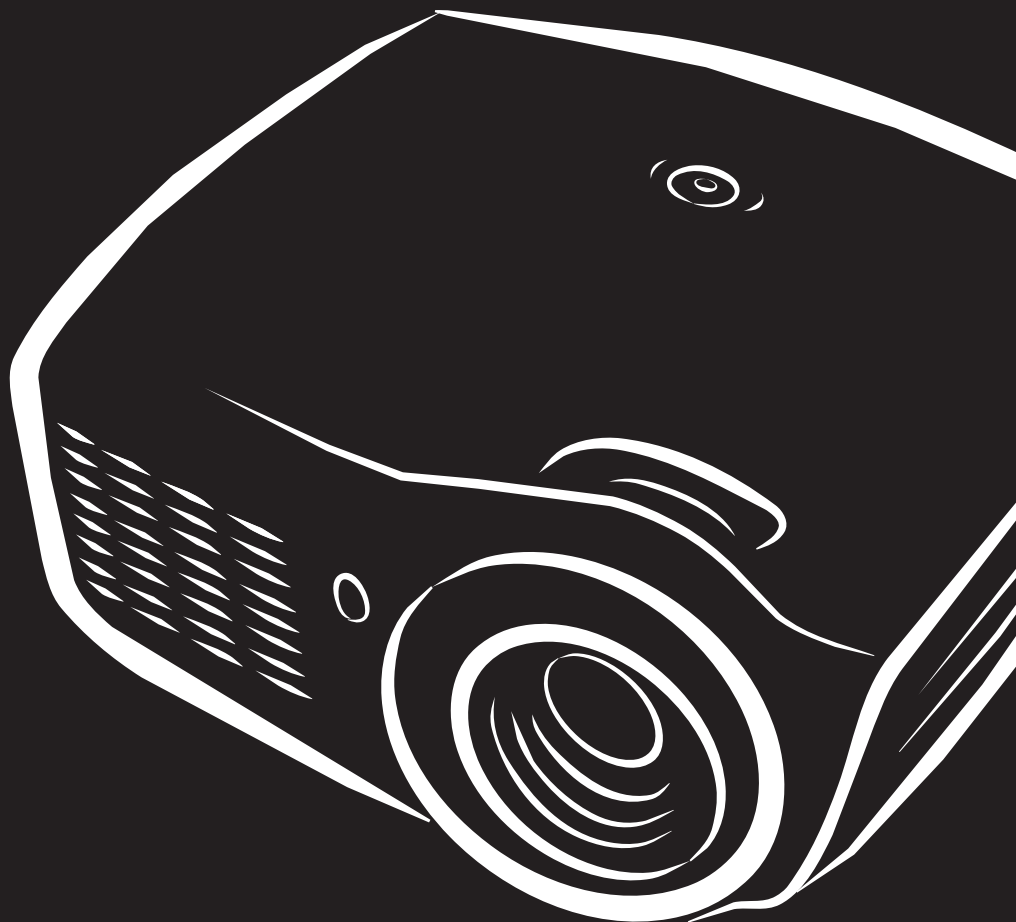

PICTURE BY  
**DLP**<sup>®</sup>  
TEXAS INSTRUMENTS

## Copyright

This publication, including all photographs, illustrations and software, is protected under international copyright laws, with all rights reserved. Neither this manual, nor any of the material contained herein, may be reproduced without written consent of the author.

© Copyright 2012

## Disclaimer

The information in this document is subject to change without notice. The manufacturer makes no representations or warranties with respect to the contents hereof and specifically disclaims any implied warranties of merchantability or fitness for any particular purpose. The manufacturer reserves the right to revise this publication and to make changes from time to time in the content hereof without obligation of the manufacturer to notify any person of such revision or changes.

## Trademark Recognition

Kensington is a U.S. registered trademark of ACCO Brand Corporation with issued registrations and pending applications in other countries throughout the world.



HDMI, the HDMI Logo, and High-Definition Multimedia Interface are trademarks or registered trademarks of HDMI Licensing LLC in the United States and other countries.

All other product names used in this manual are the properties of their respective owners and are acknowledged.

## Important Safety Information



**Important:**

*It is strongly recommended that you read this section carefully before using the projector. These safety and usage instructions will ensure that you enjoy many years of safe use of the projector.*

**Keep this manual for future reference.**

### Symbols Used

Warning symbols are used on the unit and in this manual to alert you of hazardous situations.

The following styles are used in this manual to alert you to important information.

**Note:**

*Provides additional information on the topic at hand.*



**Important:**

*Provides additional information that should not be overlooked.*



**Caution:**

*Alerts you to situations that may damage the unit.*



**Warning:**

*Alerts you to situations that may damage the unit, create a hazardous environment, or cause personal injury.*

Throughout this manual, component parts and items in the OSD menus are denoted in bold font as in this example:

“Push the **Menu** button on the remote control to open the **Main** menu.”

### General Safety Information

- Do not open the unit case. Aside from the projection lamp, there are no user-serviceable parts in the unit. For servicing, contact qualified service personnel.
- Follow all warnings and cautions in this manual and on the unit case.
- The projection lamp is extremely bright by design. To avoid damage to eyes, do not look into the lens when the lamp is on.
- Do not place the unit on an unstable surface, cart, or stand.
- Avoid using the system near water, in direct sunlight, or near a heating device.
- Do not place heavy objects such as books or bags on the unit.

### Projector Installation Notice

- Place the projector in a horizontal position  
**The tilt angle of the projector should not exceed 15 degrees**, nor should the projector be installed in any way other than the desktop and ceiling mount, otherwise lamp life could decrease dramatically, and may lead to other **unpredictable damages**.

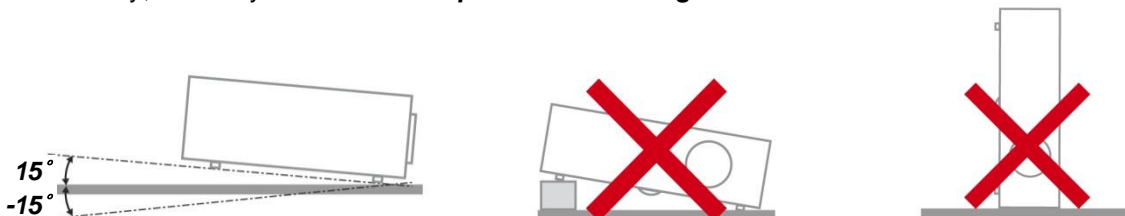

- Allow at least 50 cm clearance around the exhaust vent.

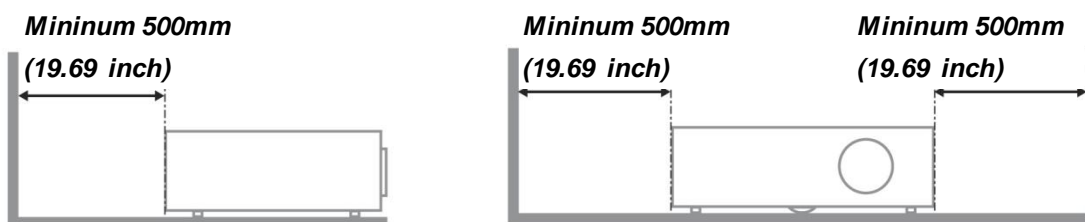

- 

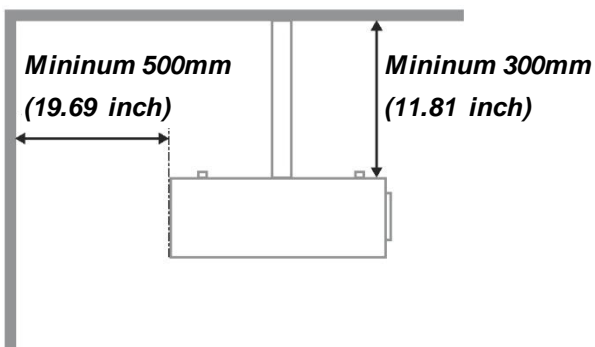
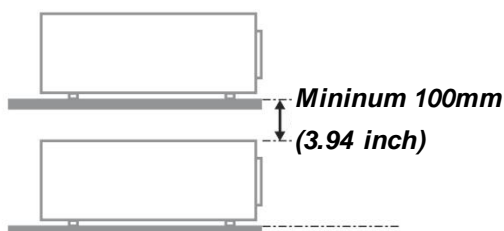
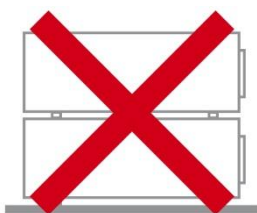

- Ensure that the intake vents do not recycle hot air from the exhaust vent.
- When operating the projector in an enclosed space, ensure that the surrounding air temperature within the enclosure does not exceed operation temperature while the projector is running, and the air intake and exhaust vents are unobstructed.
- All enclosures should pass a certified thermal evaluation to ensure that the projector does not recycle exhaust air, as this may cause the device to shutdown even if the enclosure temperature is within the acceptable operation temperature range.

### **Verify Installation Location**

- To supply power, the 3-blade (with earthing lead) socket should be used to ensure proper grounding and equalized ground potential for all of the equipment in the Projector System.
- The power code provided with the Projector should be used. In case of any missing item, other qualified 3-blade (with earthing lead) power cord can be used as substitution; however, do not use 2-blade power cord.
- Verify if the voltage is stable, grounded properly and there is no electricity leakage.
- Measure total power consumption which should not higher the safety capacity and avoid safety issue and short circuit.
- Turn on Altitude Mode when located in high altitude areas
- The projector can only be installed upright or inverted.
- When installation the bracket, make sure the weight limit is not exceed and firmly secured.
- Avoid installing near air conditioner duct or subwoofer.
- Avoid installing at high temperature, insufficient cooling and heavy dust locations.
- Keep your product away from fluorescent lamps to avoid malfunction caused by IR interference
- The VGA IN connector should be connected to the VGA IN port. Note that it should be inserted tightly, with the screws on both sides securely fastened to ensure proper connection of the signal wire for achieving optimal display effect.
- The AUDIO IN connector should be connected to the AUDIO IN port and CANNOT be connected to AUDIO OUT or other ports like BNC, RCA; otherwise, it will lead to mute output and even DAMAGE the port.
- Install the projector above 200cm to avoid damage.
- The power cord and signal cable should be connected before power on the projector. During the projector starting and operating process, DO NOT insert or remove the signal cable or the power cord to avoid damaging the projector.

### **Cooling notes**

#### **Air outlet**

- Make sure the air outlet is 50cm clear of any obstruction to ensure proper cooling.
- Air outlet location should not be in front of the lens of other projector to avoid causing illusions.
- Keep the outlet at least 100cm away from the inlets of other projectors
- The projector generates a massive amount of heat during use. The internal fan dissipates the heat of the projector when shutting down, and such process may continue for a certain period. After the project enters STANDBY MODE status, press the AC power button to turn off the projector and remove the power cord. DO NOT remove the power cord during the shutdown process, as it may cause damage to the projector. In the meantime, the delayed heat radiating will also affect the service life of the projector. The shutdown process may vary depending on the model used. Whatever the case may be, be sure to disconnect the power cord till after the projector enters the STANDBY status.

#### **Air inlet**

- Make sure there is no object blocking air input within 30 cm.
- Keep the inlet away from other heat sources
- Avoided heavy dust area

## Power Safety

- Only use the supplied power cord.
- Do not place anything on the power cord. Place the power cord where it will not be in the way of foot traffic.
- Remove the batteries from the remote control when storing or not in use for a prolonged period.

## Replacing the Lamp

Replacing the lamp can be hazardous if done incorrectly. See [Replacing the Projection Lamp](#) on page 63 for clear and safe instructions for this procedure. Before replacing the lamp:

- Unplug the power cord.
- Allow the lamp to cool for about one hour.



### Caution:

*In rare cases the lamp bulb may burn out during normal operation and cause glass dust or shards to be discharged outward from the rear exhaust vent.*

*Do not inhale or do not touch glass dust or shards. Doing so could result in injury.*

*Always keep your face away from the exhaust vent so that you do not suffer from the gas and broken shards of the lamp.*

## Cleaning the Projector

- Unplug the power cord before cleaning. See [Cleaning the Projector](#) page 66.
- Allow the lamp to cool for about one hour.

## Regulatory Warnings

Before installing and using the projector, read the regulatory notices in the [Regulatory Compliance](#) on page 79.

### Important Recycle Instructions:



Lamp(s) inside this product contain mercury. This product may contain other electronic waste that can be hazardous if not disposed of properly. Recycle or dispose in accordance with local, state, or federal Laws. For more information, contact the Electronic Industries Alliance at [WWW.EIAE.ORG](http://WWW.EIAE.ORG). For lamp specific disposal information check [WWW.LAMPRECYCLE.ORG](http://WWW.LAMPRECYCLE.ORG).

## Symbol Explanations



DISPOSAL: Do not use household or municipal waste collection services for disposal of electrical and electronic equipment. EU countries require the use of separate recycling collection services.

## **Main Features**

- *Lightweight unit, easy to pack away and transport.*
- *Compatible with all major video standards including NTSC, PAL, and SECAM.*
- *A high brightness rating allows for presentations in daylight or in lit rooms.*
- *Supports resolutions up to UXGA at 16.7 million colors to deliver crisp, clear images.*
- *Flexible setup allows for front, rear projections.*
- *Line-of-vision projections remain square, with advanced keystone correction for angled projections.*
- *Input source automatically detected.*

## **About this Manual**

This manual is intended for end users and describes how to install and operate the DLP projector. Wherever possible, relevant information—such as an illustration and its description—has been kept on one page. This printer-friendly format is both for your convenience and to help save paper, thereby protecting the environment. It is suggested that you only print sections that are relevant to your needs.

---

## Table of Contents

<b>GETTING STARTED .....</b>	<b>1</b>
PACKING CHECKLIST.....	1
<i>Standard Accessories</i> .....	1
<i>Optional Accessories</i> .....	1
VIEWS OF PROJECTOR PARTS .....	2
<i>Front-right View</i> .....	2
<i>Top view—On-screen Display (OSD) buttons and LEDs</i> .....	3
<i>Rear view</i> .....	4
<i>Bottom view</i> .....	5
REMOTE CONTROL PARTS .....	6
REMOTE CONTROL OPERATING RANGE.....	8
PROJECTOR AND REMOTE CONTROL BUTTONS .....	8
<i>Inserting the Remote Control Batteries</i> .....	9
<b>SETUP AND OPERATION.....</b>	<b>10</b>
STARTING AND SHUTTING DOWN THE PROJECTOR .....	10
SETTING AN ACCESS PASSWORD (SECURITY LOCK).....	12
ADJUSTING THE PROJECTOR LEVEL.....	14
ADJUSTING THE ZOOM, FOCUS AND KEYSTONE .....	15
ADJUSTING THE VOLUME .....	15
<b>ON-SCREEN DISPLAY (OSD) MENU SETTINGS.....</b>	<b>16</b>
OSD MENU CONTROLS .....	16
<i>Navigating the OSD</i> .....	16
SETTING THE OSD LANGUAGE .....	17
OSD MENU OVERVIEW .....	18
IMAGE MENU .....	21
<i>Advanced Feature</i> .....	22
<i>Color Manager</i> .....	23
COMPUTER MENU .....	24
VIDEO/AUDIO MENU.....	25
<i>Audio</i> .....	26
INSTALLATION I MENU .....	27
<i>Advanced Feature</i> .....	28
INSTALLATION II MENU .....	29
<i>Advanced Feature</i> .....	30
<i>Factory Reset</i> .....	39
<i>Status</i> .....	39
<b>MEDIA OVERVIEW .....</b>	<b>40</b>
FEATURES.....	40
MEDIA MENU .....	40
<b>MENU SETTINGS .....</b>	<b>41</b>
MEDIA .....	41
VIVI DISPLAY .....	42
SETTINGS.....	43
<i>System</i> .....	43
<i>Video</i> .....	43
<i>Photo</i> .....	44
<i>Audio</i> .....	44
<i>Wifi</i> .....	45
<b>USING THE MEDIA .....</b>	<b>46</b>
INSTALLING VIVI DISPLAY .....	46
<i>ViVi Display requirement</i> .....	46
<i>To install the utility</i> .....	47
MAKING CONNECTIONS .....	50



LAN Connection.....	50
WiFi Connecting .....	52
Connecting a USB Device .....	54
DISPLAY MEDIA .....	56
Viewing Photos .....	56
Viewing Movies.....	57
Music .....	58
Office viewer.....	60
<b>SUPPORTED MEDIA SPECIFICATIONS .....</b>	<b>61</b>
SUPPORTED PHOTO FORMATS .....	61
SUPPORTED MUSIC FORMATS .....	61
SUPPORTED MOVIE FORMATS .....	62
SUPPORTED DOCUMENT FORMATS .....	62
<b>MAINTENANCE AND SECURITY .....</b>	<b>63</b>
REPLACING THE PROJECTION LAMP.....	63
Resetting the Lamp .....	65
CLEANING THE PROJECTOR.....	66
Cleaning the Lens .....	66
Cleaning the Case .....	66
USING THE KENSINGTON® LOCK & USING THE SECURITY BAR.....	67
Using the Kensington® Lock.....	67
Using the Security Bar.....	67
<b>TROUBLESHOOTING.....</b>	<b>68</b>
COMMON PROBLEMS AND SOLUTIONS .....	68
TIPS FOR TROUBLESHOOTING.....	68
LED ERROR MESSAGES .....	69
IMAGE PROBLEMS.....	69
LAMP PROBLEMS.....	70
REMOTE CONTROL PROBLEMS .....	70
AUDIO PROBLEMS .....	71
HAVING THE PROJECTOR SERVICED .....	71
HDMI Q & A .....	72
<b>SPECIFICATIONS.....</b>	<b>73</b>
SPECIFICATIONS.....	73
PROJECTION DISTANCE VS. PROJECTION SIZE .....	74
Projection Distance and Size Table .....	74
TIMING MODE TABLE.....	76
PROJECTOR DIMENSIONS .....	78
<b>REGULATORY COMPLIANCE.....</b>	<b>79</b>
FCC WARNING .....	79
CANADA.....	79
SAFETY CERTIFICATIONS .....	79
<b>APPENDIX I.....</b>	<b>80</b>
RS-232C PROTOCOL.....	80

# GETTING STARTED

## Packing Checklist

Carefully unpack the projector and check that the following items are included:

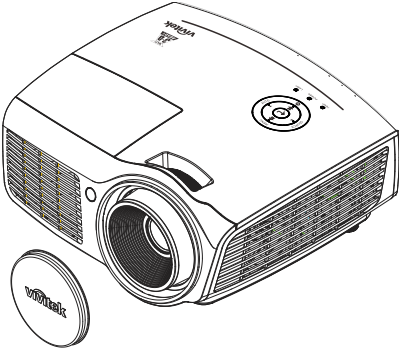

DLP PROJECTOR WITH LENS CAP

## Standard Accessories

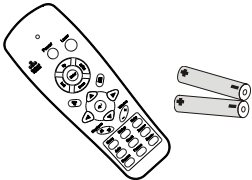

REMOTE CONTROL  
(WITH TWO AAA BATTERIES)

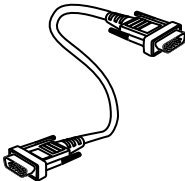

RGB CABLE



POWER CORD



CD-ROM  
(THIS USER'S MANUAL)



QUICK START GUIDE



WARRANTY CARD

## Optional Accessories

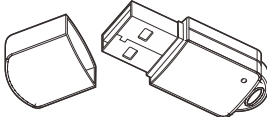

WiFi DONGLE

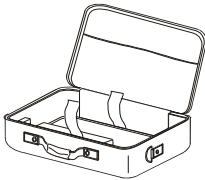

CARRYING CASE

Contact your dealer immediately if any items are missing, appear damaged, or if the unit does not work. It is recommended that you keep the original packing material should you ever need to return the equipment for warranty service.

**Caution:**  
Avoid using the projector in dusty environments.

Views of Projector Parts

Front-right View

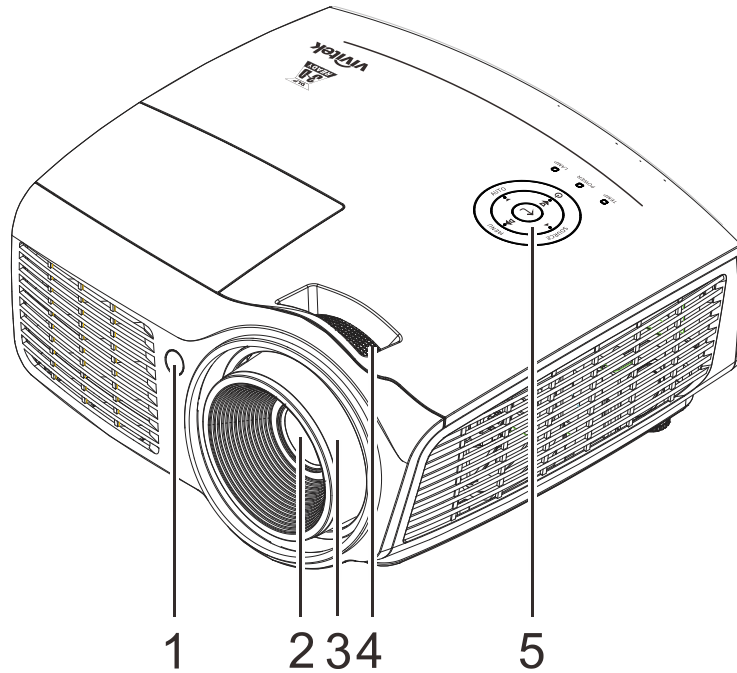

ITEM	LABEL	DESCRIPTION	SEE PAGE:
1.	IR receiver	Receive IR signal from remote control	
2.	Lens	Projection Lens	
3.	Focus ring	Focuses the projected image	15
4.	Zoom ring	Enlarges the projected image	
5.	Function keys	See Top view—On-screen Display (OSD) buttons and LEDs.	3



**Important:**

Ventilation openings on the projector allow for good air circulation, which keeps the projector lamp cool. Do not obstruct any of the ventilation openings.

Top view—On-screen Display (OSD) buttons and LEDs

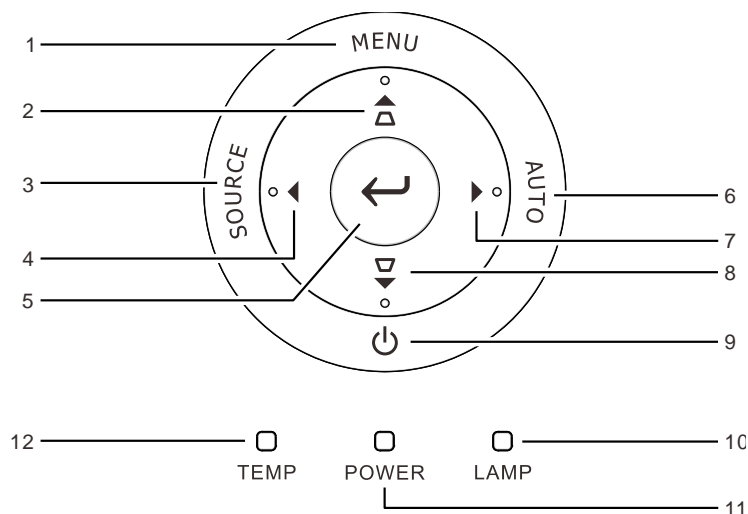

ITEM	LABEL	DESCRIPTION		SEE PAGE:
1.	MENU	Opens and exits OSD menus		16
2.	▲ (Up cursor) / Keystone+	Navigates and changes settings in the OSD Quick Menu – For Keystone Under Media function: Navigates and changes settings in the Media menu		16
3.	SOURCE	Enter the Source menu		
4.	◀ (Left cursor) / Volume-	Navigates and changes settings in the OSD Quick Menu – For Volume Under Media function: Navigates and changes settings in the Media menu		
5.	↵ Enter	Enter or confirm highlighted OSD menu item Under Media function: Enter or confirm highlighted settings in the Media menu		
6.	AUTO	Optimizes image size, position, and resolution Under Media function: Return to Media menu		
7.	▶ (Right cursor) / Volume+	Navigates and changes settings in the OSD Quick Menu – For Volume Under Media function: Navigates and changes settings in the Media menu		16
8.	▼ (Down cursor) / Keystone-	Navigates and changes settings in the OSD Quick Menu – For Keystone Under Media function: Navigates and changes settings in the Media menu		
9.	⏻ (Power button)	Turns the projector On or Off.		
10.	LAMP LED	Solid Red	Lamp Error.	69
		Flashing Red	Lamp temperature too high	
11.	POWER LED	Solid Green	Power On	
		Flashing Green	System Initialized / Cooling / Error code	
12.	TEMP LED	Solid Red	Over temperature	



Rear view

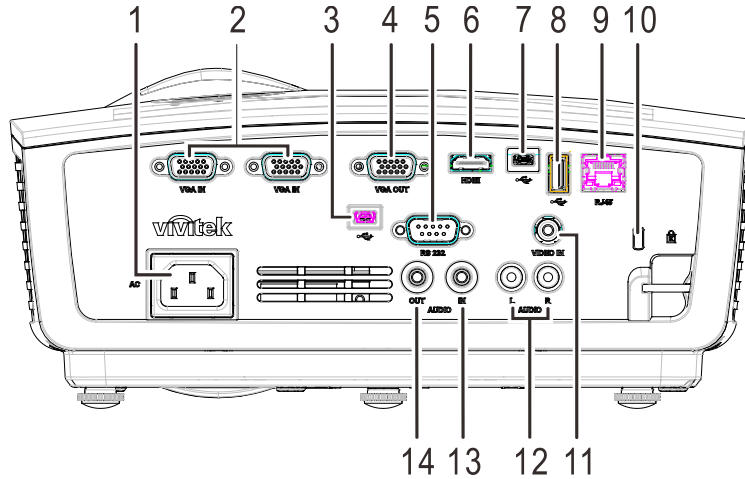

**Warning:**

As a safety precaution, disconnect all power to the projector and connecting devices before making connections.



ITEM	LABEL	DESCRIPTION	SEE PAGE:
1.	AC IN	Connect the POWER cable	10
2.	VGA IN	Connect the RGB cable from a computer	
3.	 (USB Mini B)	System firmware download service only. Connect the USB cable from a computer. IR remote control for keyboard	
4.	VGA OUT	Connect the RGB cable to a display.	
5.	RS-232C	Connect RS-232 serial port cable for remote control.	
6.	HDMI	Connect the HDMI cable from a HDMI device.	
7.	 (USB Mini A)	Connect the USB cable from a computer for Multi-media Display.	
8.	 (USB Type A)	Connect USB disc or optional WIFI dongle for Multi-media display.	
9.	RJ-45	Connect a LAN cable from Ethernet.	
10.	Kensington Lock	Secure to permanent object with a Kensington® Lock system.	67
11.	VIDEO IN	Connect the COMPOSITE cable from a video device	
12.	AUDIO IN (L and R)	Connect the AUDIO cable from a audio device.	
13.	AUDIO IN	Connect an AUDIO cable from the audio device.	
14.	AUDIO OUT	Connect an AUDIO cable to audio amplifier.	

Bottom view

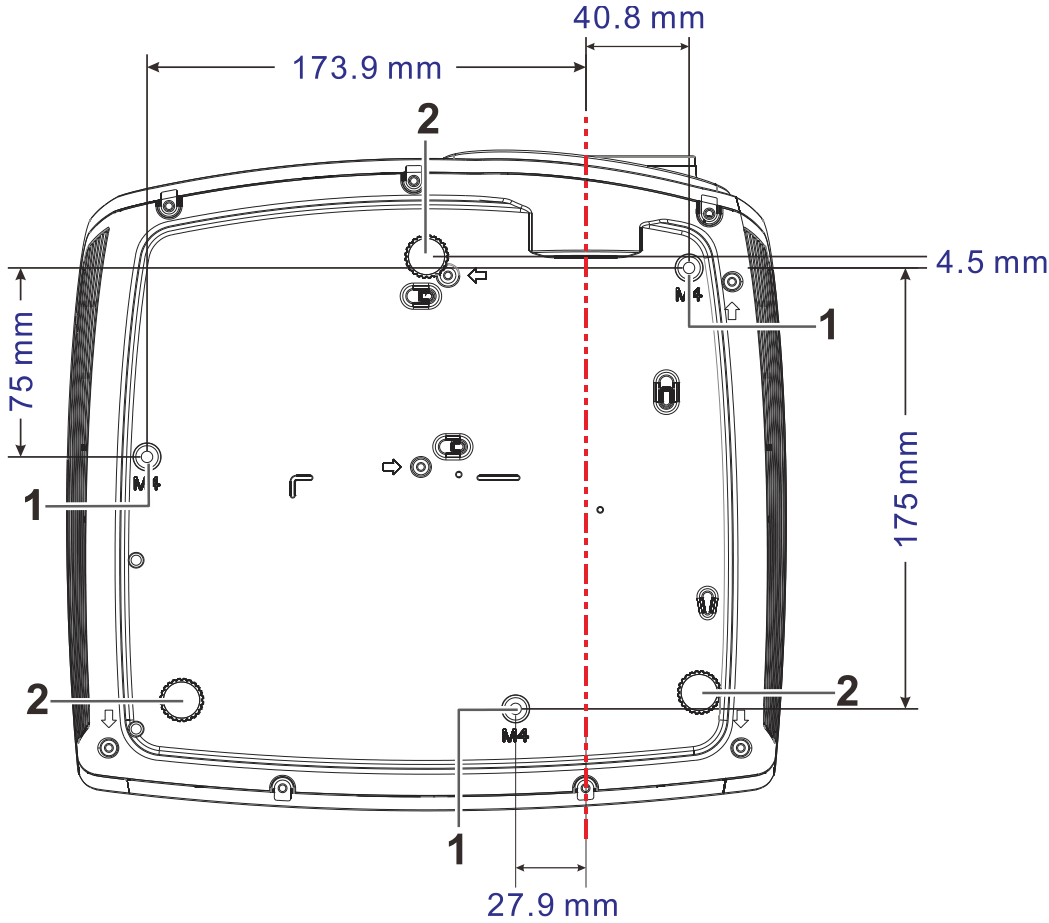

ITEM	LABEL	DESCRIPTION	SEE PAGE:
1.	Ceiling support holes	Contact your dealer for information on mounting the projector on a ceiling	
2.	Tilt adjustor	Rotate adjuster lever to adjust angle position.	14

**Note:**  
 When installing, ensure that you use only UL Listed ceiling mounts.  
 For ceiling installations, use approved mounting hardware and M4 screws with a maximum screw depth of 12 mm (0.47 inch).  
 The construction of the ceiling mount must be of a suitable shape and strength. The ceiling mount load capacity must exceed the weight of the installed equipment, and as an additional precaution be capable of withstanding three times the weight of the equipment (not less than 5.15 kg) over a period of 60 seconds.

## Remote Control Parts

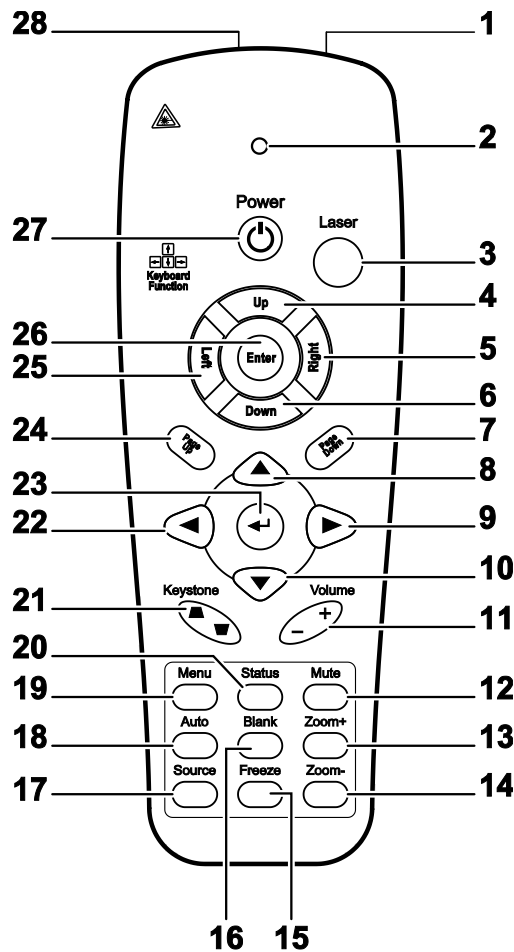

**!** **Important:**

1. Avoid using the projector with bright fluorescent lighting turned on. Certain high-frequency fluorescent lights can disrupt remote control operation.
2. Be sure nothing obstructs the path between the remote control and the projector. If the path between the remote control and the projector is obstructed, you can bounce the signal off certain reflective surfaces such as projector screens.
3. The buttons and keys on the projector have the same functions as the corresponding buttons on the remote control. This user's manual describes the functions based on the remote control.

**Note:**

Complies with FDA performance standards for laser products except for deviations pursuant to Laser Notice No. 50, dated June 24, 2007

ITEM	LABEL	DESCRIPTION	SEE PAGE:
1.	IR transmitter	Transmits signals to projector	
2.	Status LED	Lights when the remote control is used	
3.	Laser	Press to operate the on-screen pointer	
4.	Up	Up arrow when connected through USB to a PC	
5.	Right	Right arrow when connected through USB to a PC	
6.	Down	Down arrow when connected through USB to a PC	
7.	Page Down	Page down when connected through USB to a PC	
8.	Up cursor	Navigates and changes settings in the OSD	16
9.	Right cursor		
10.	Down cursor		
11.	Volume +/-	Adjusts volume	15
12.	Mute	Mutes the built-in speaker	
13.	Zoom+	Zoom in	
14.	Zoom-	Zoom out	
15.	Freeze	Freeze/unfreezes the on-screen picture	
16.	Blank	Makes the screen blank	
17.	Source	Detects the input device	
18.	Auto	Auto adjustment for phase, tracking, size, position Under Media function: Return to Media menu	
19.	Menu	Opens the OSD	16
20.	Status	Opens the OSD Status menu (the menu only opens when an input device is detected)	39
21.	Keystone top/bottom	Corrects image-trapezoid (wider top/bottom) effect	15
22.	Left cursor	Navigates and changes settings in the OSD	16
23.	Enter	Changes settings in the OSD	
24.	Page Up	Page up when connected through USB to a PC	
25.	Left	Left arrow when connected through USB to a PC	
26.	Enter	Enter key when connected through USB to a PC	
27.	Power	Turns the projector on or off	10
28.	Laser	Use as on-screen pointer. <b>DO NOT POINT IN EYES.</b>	





**Caution:**

*Use of controls, adjustments or performance of procedures other than those specified herein may result in hazardous laser light exposure.*

### **Remote Control Operating Range**

The remote control uses infrared transmission to control the projector. It is not necessary to point the remote directly at the projector. Provided you are not holding the remote perpendicular to the sides or the rear of the projector, the remote will function well within a radius of about 7 meters (23 feet) and 15 degrees above or below the projector level. If the projector does not respond to the remote control, move a little closer.

### **Projector and Remote Control Buttons**

The projector can be operated using the remote control or the buttons on the top of the projector. All operations can be carried out with the remote control exclude Keypad Function; however, the buttons on the projector are limited in use.

## Inserting the Remote Control Batteries

1. Remove the battery compartment cover by sliding the cover in the direction of the arrow.

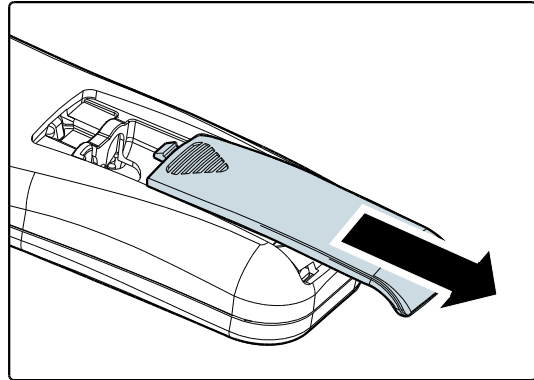

2. Insert the battery with the positive side facing up.

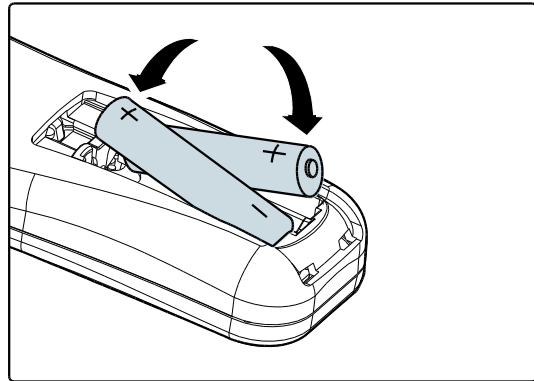

3. Replace the cover.

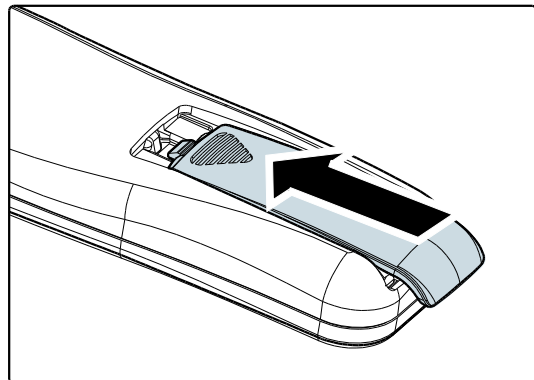

**Caution:**

1. Only use AAA batteries (Alkaline batteries are recommended).
2. Dispose of used batteries according to local ordinance regulations.
3. Remove the batteries when not using the projector for prolonged periods.

## Starting and Shutting down the Projector

1. Connect the power cord to the projector. Connect the other end to a wall outlet.

The  **POWER** LED on the projector light.

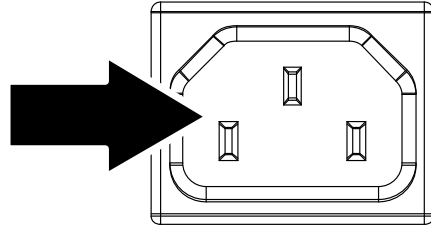

2. Turn on the connected devices.

3. Ensure the POWER LED not a flashing. Then press the  **POWER** button to turn on the projector.

The projector splash screen displays and connected devices are detected.

See [Setting an Access Password \(Security Lock\)](#) on page 12 if security lock is enabled.



4. If more than one input device is connected, press the **SOURCE** button and use ▲▼ to scroll among devices.  
(Component is supported through the RGB to COMPONENT ADAPTER.)

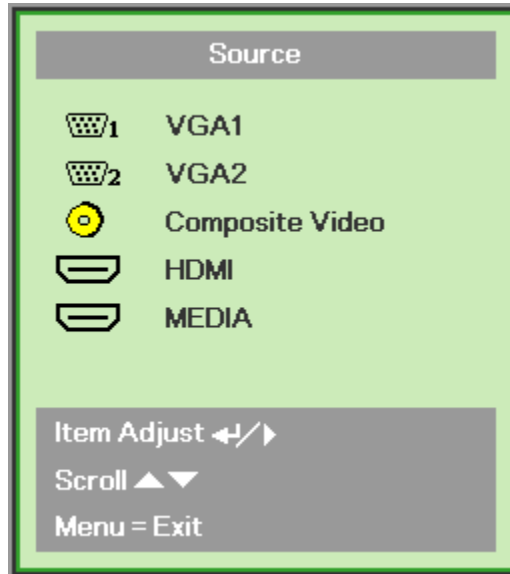

- VGA1/VGA2: Analog RGB
- Composite Video: Traditional composite video
- HDMI: High-Definition Multimedia Interface
- MEDIA: Media Board

5. When the “Power Off? /Press **Power** again” message appears, press the **POWER** button. The projector turns off.

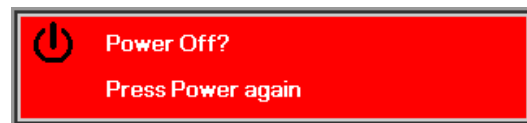

**Caution:**

1. Be sure to remove the lens cap before starting projector.
2. Do not unplug the power cord until the POWER LED stops flashing—indicating the projector has cooled down.

## Setting an Access Password (Security Lock)

You can use the four (arrow) buttons to set a password and prevent unauthorized use of the projector. When enabled, the password must be entered after you power on the projector. (See [Navigating the OSD](#) on page 16 and [Setting the OSD Language](#) on page 17 for help on using OSD menus.)



**Important:**

Keep the password in a safe place. Without the password, you will not be able to use the projector. If you lose the password, contact your reseller for information on clearing the password.

1. Press the **MENU** button to open the OSD menu.
2. Press the cursor ◀▶ button to move to the **Installation I** menu, press the cursor ▲▼ button to select **Advanced**.

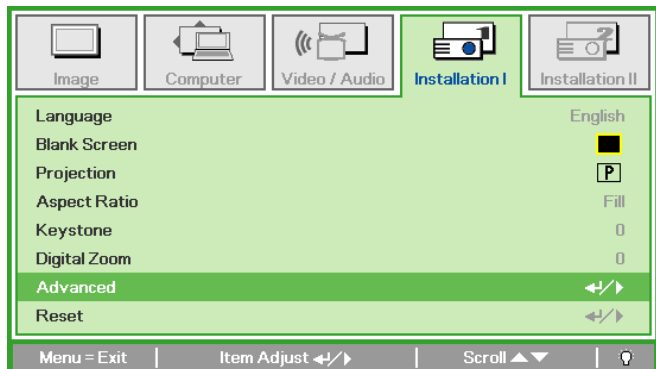
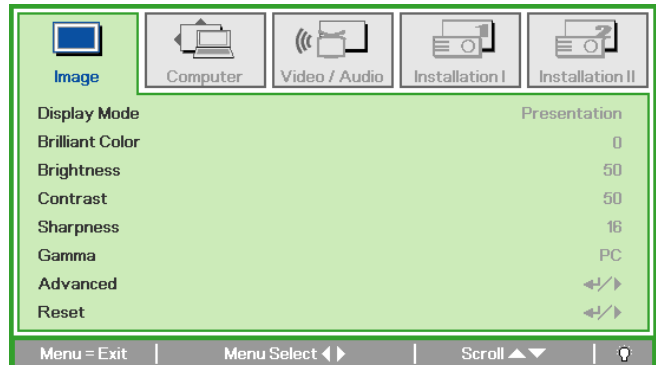

3. Press the cursor ▲▼ button to select **Security Lock**.
4. Press the cursor ◀▶ button to enable or disable security lock function.

A password dialog box automatically appears.

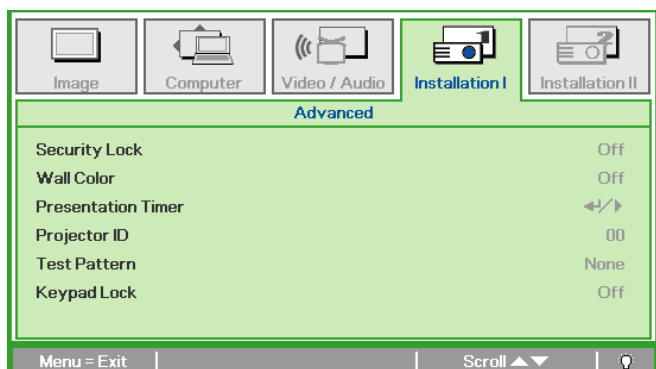

- 5.** You can use the cursor buttons ▲▼◀▶ either on keypad or IR remote control for password entry. You can use any combination including the same arrow five times, but not less than five.

Press the cursor buttons in any order to set the password. Push the **MENU** button to exit the dialog box.

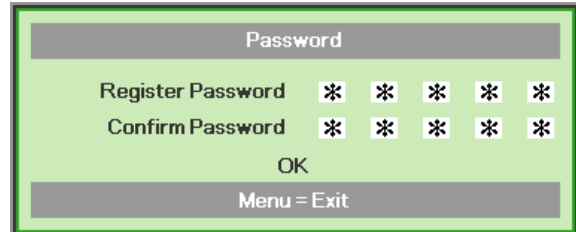
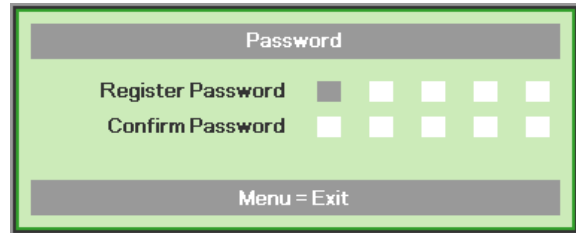

- 6.** The password confirm menu appears when user presses the power-on key in case the **Security Lock** is enabled. Enter the password in the order you set it at step 5. In case you forget the password, please contact the service center. The service center will validate the owner and help reset the password.

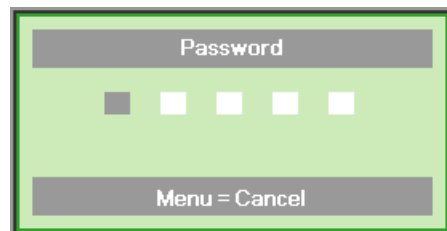

## Adjusting the Projector Level

Take note of the following when setting up the projector:

- *The projector table or stand should be level and sturdy.*
- *Position the projector so that it is perpendicular to the screen.*
- *Ensure the cables are in a safe location. You could trip over them.*

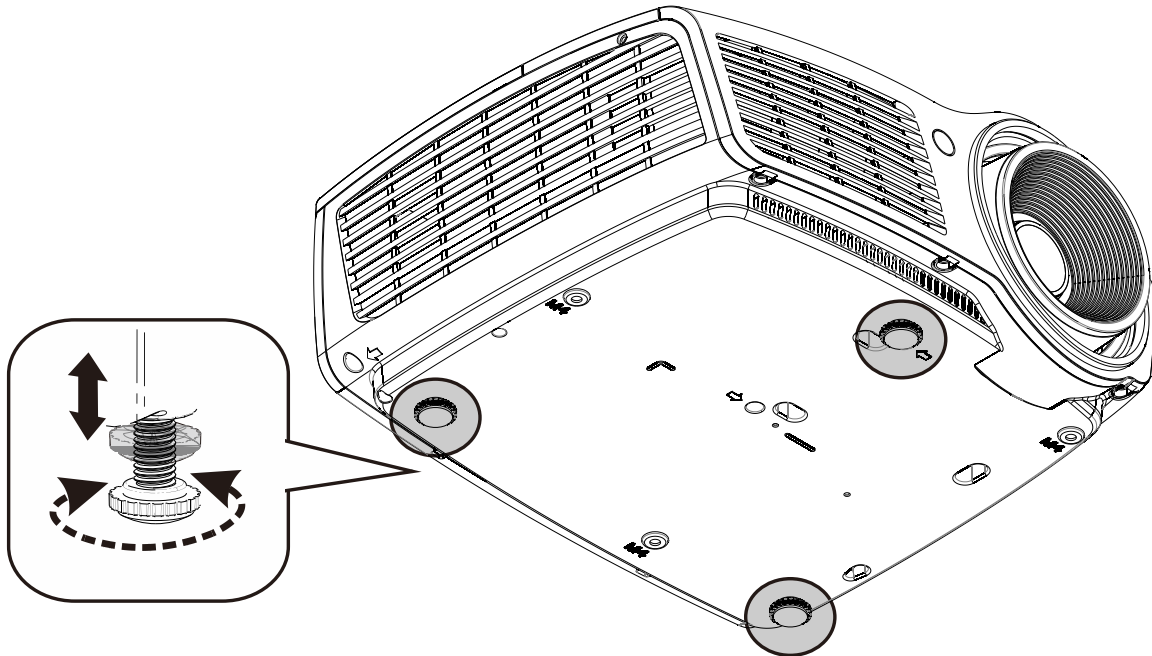

To adjust the angle of the picture, turn the tilt-adjuster right or left until the desired angle has been achieved.

## Adjusting the Zoom, Focus and Keystone

1. Use the **Image-zoom** control (on the projector only) to resize the projected image and screen size **(B)**.

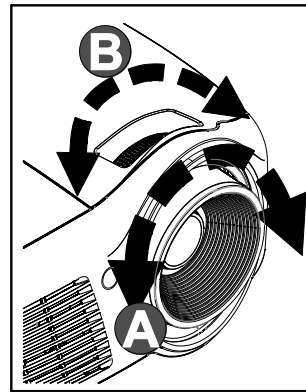

2. Use the **Image-focus** control (on the projector only) to sharpen the projected image **(A)**.

3. Use the **KEYSTONE** buttons the remote control to correct image-trapezoid (wider top or bottom) effect.

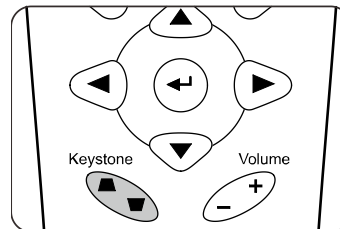

4. The keystone control appears on the display.

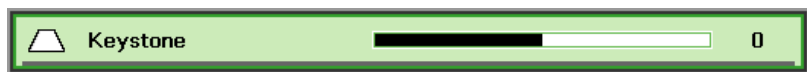

## Adjusting the Volume

1. Press the **Volume +/-** buttons on the remote control. The volume control appears on the display.

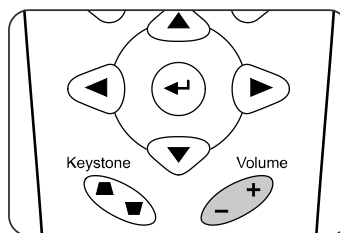

2. Press the **MUTE** button to turn off the volume.





## ON-SCREEN DISPLAY (OSD) MENU SETTINGS

### OSD Menu Controls

The projector has an OSD that lets you make image adjustments and change various settings.

#### Navigating the OSD

You can use the remote control cursor buttons to navigate and make changes to the OSD.

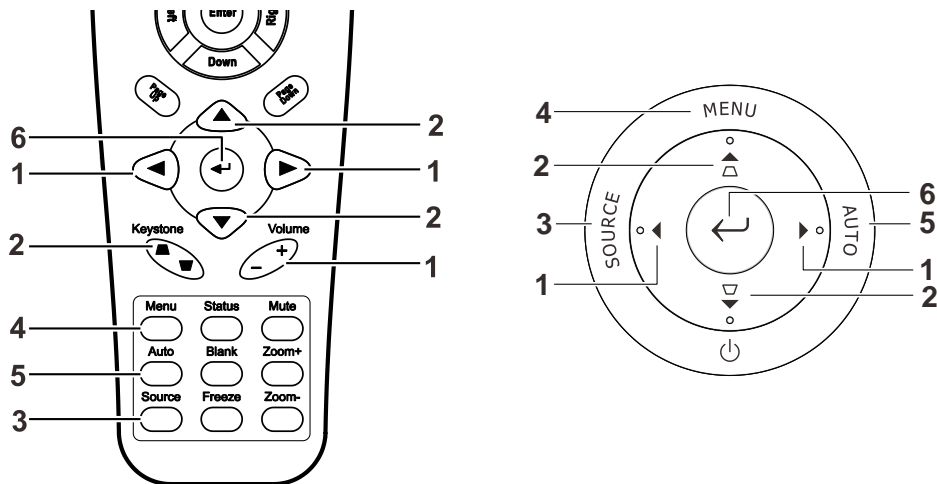

1. To enter the OSD, press the **MENU** button.
2. There are five menus. Press the cursor ◀▶ button to move through the menus.
3. Press the cursor ▲▼ button to move up and down in a menu.
4. Press ◀▶ to change values for settings.
5. Press **MENU** to close the OSD or leave a submenu.

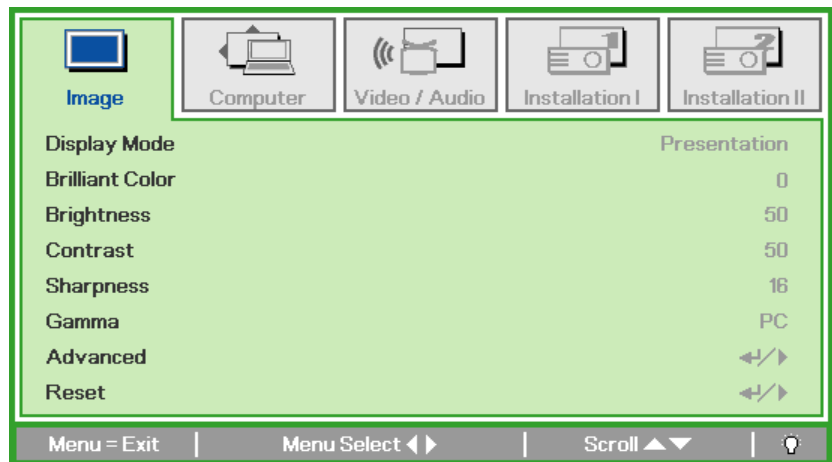

**Note:**

Depending on the video source, not all items in the OSD are available. For example, the **Horizontal/Vertical Position** items in the **Computer** menu can only be modified when connected to a PC. Items that are not available cannot be accessed and are grayed out.

## Setting the OSD Language

Set the OSD language to your preference before continuing.

1. Press the **MENU** button. Press the cursor ◀▶ button to navigate to Installation I.

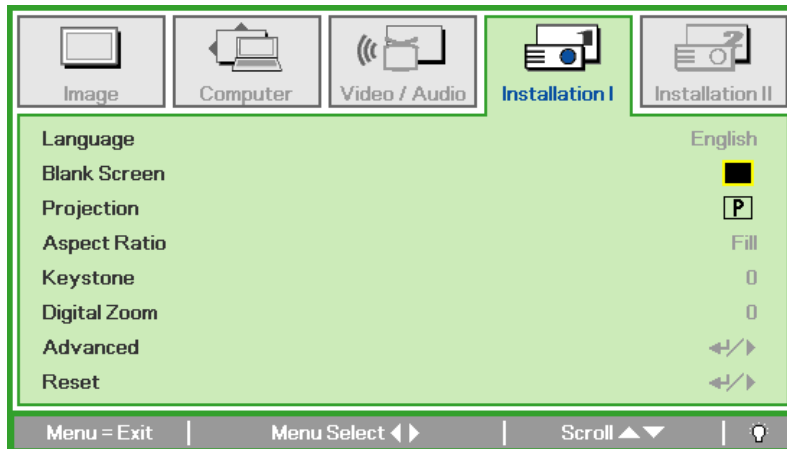

2. Press the cursor ▲▼ button until **Language** is highlighted.

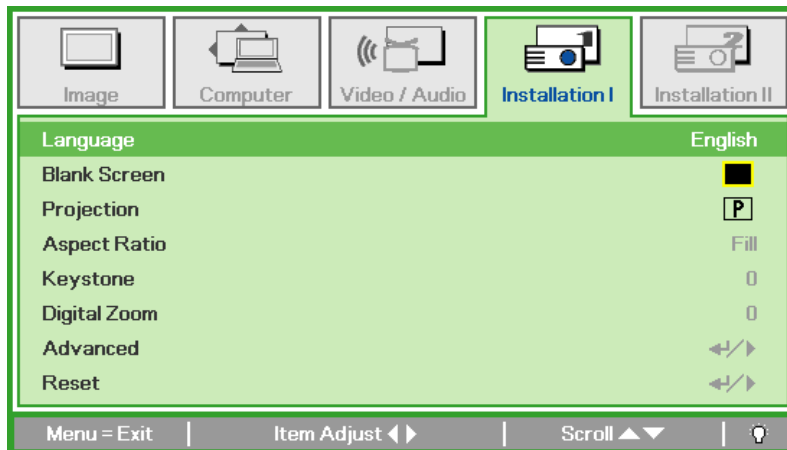

3. Press the cursor ◀▶ button until the language you want is highlighted.
4. Press the **MENU** button twice to close the OSD.

## OSD Menu Overview

Use the following illustration to quickly find a setting or determine the range for a setting.

MAIN MENU	SUB MENU	SETTINGS		
Image	Display Mode	Presentation, Bright, Game, Movie, TV, sRGB, Blackboard, User		
	Brilliant Color	0~10		
	Brightness	0~100		
	Contrast	0~100		
	Sharpness	0~31		
	Gamma	PC, MAC, Video, Chart, B&W		
	Advanced	Color Space	Auto, RGB, YCbCr, YPbPr	
		Color Temperature	Cold, Normal, Warm	
		Color Manager	Red	Hue, Saturation, Gain
			Green	Hue, Saturation, Gain
			Blue	Hue, Saturation, Gain
Cyan			Hue, Saturation, Gain	
Magenta			Hue, Saturation, Gain	
Yellow	Hue, Saturation, Gain			
White	Red, Green, Blue			
Reset				
Computer	Horizontal Position	-5~5		
	Vertical Position	-5~5		
	Frequency	0~31		
	Tracking	-5~5		
	Auto Image			
Video/Audio	Video AGC	Off, On		
	Video Saturation	0~100		
	Video Tint	0~100		
	Film Mode	Auto, Off		
	Video Overscan	Off, On		
	Closed Captioning	Off, On		
	Audio	Volume	0~8	
		Mute	Off, On	
Reset				

MAIN MENU	SUB MENU	SETTINGS		
Installation I	Language	English, Français, Deutsch, Español, Português, 简体中文, 繁體中文, Italiano, Norsk, Svenska, Nederlands, Русский, Polski, Suomi, Ελληνικά, 한국어, Magyar, Čeština, العربية, Türkçe		
	Blank Screen	Black, Red, Green, Blue, White		
	Projection	Front, Rear, Ceiling, Rear + Ceiling		
	Aspect Ratio	Fill, 4:3, 16:9, Letter Box, Native		
	Keystone	-40~40		
	Digital Zoom	-10~10		
	Advanced	Security Lock	Off ,On	
		Wall Color	Off, Light Yellow, Pink, Light Green, Blue, Blackboard	
		Presentation Timer	Timer	Off ,On
			Timer Period	1-60
			Timer Reset	
		Projector ID	0~98	
		Test Pattern	None, RGB Ramps, Color Bars, Step Bars, Check board, Grid, Horizontal Lines, Vertical Lines, Horizontal Ramp, Vertical Ramp, While	
	Keypad Lock	Off ,On		
Reset				

MAIN MENU	SUB MENU	SETTINGS		
Installation II	Auto Source	Off, On		
	Auto Power Off (min.)	0~180		
	Auto Power On	Off, On		
	Fan Speed	Normal, High		
	Lamp Mode	Std., Boost		
	Advanced	OSD Menu Setting	Menu Position	Center, Down, Up, Left, Right
			Translucent Menu	0%, 25%, 50%, 75%, 100%
			Menu Display	10~20
		Peripheral Test	Remote Control Test	
			Color Test	
			Button Test	
			USB Test	
		Lamp Hour Reset		
		Low Power Mode	On, Off	
		3D	3D	Off, DLP-Link, nVidia
			3D Sync Invert	On, Off
		Network	Network State	Disconnect, Connect
			DHCP	Off, On
			IP Address	0~255, 0~255, 0~255, 0~255
			Subnet Mask	0~255, 0~255, 0~255, 0~255
	Gateway		0~255, 0~255, 0~255, 0~255	
	DNS		0~255, 0~255, 0~255, 0~255	
	Apply			
	Factory Reset			
	Status	Active Source		
		Video Information		
		Lamp Hours (Std., Boost)		

## Image Menu

Press the **MENU** button to open the **OSD** menu. Press the cursor **◀▶** button to move to the **Image Menu**. Press the cursor **▲▼** button to move up and down in the **Image** menu. Press **◀▶** to change values for settings.

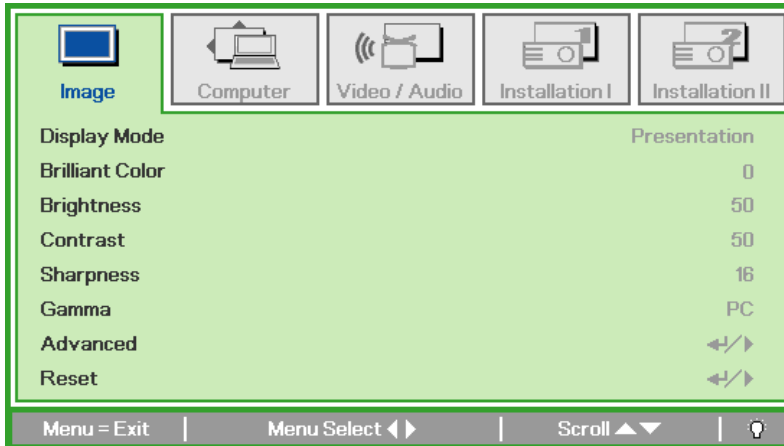

ITEM	DESCRIPTION
Display Mode	Press the cursor <b>◀▶</b> button to set the Display Mode.
Brilliant Color	Press the cursor <b>◀▶</b> button to adjust the Brilliant Color value.
Brightness	Press the cursor <b>◀▶</b> button to adjust the display brightness.
Contrast	Press the cursor <b>◀▶</b> button to adjust the display contrast.
Sharpness	Press the cursor <b>◀▶</b> button to adjust the display sharpness level.
Gamma	Press the cursor <b>◀▶</b> button to adjust the gamma correction of the display.
Advanced	Press <b>↵</b> (Enter) / <b>▶</b> to enter the Advanced menu. See <a href="#">Advanced Feature</a> on page 22.
Reset	Press <b>↵</b> (Enter) / <b>▶</b> to reset all settings to default values.

### Advanced Feature

Press the **Menu** button to open the **OSD** menu. Press **◀▶** to move to the **Image** menu. Press **▼▲** to move to the **Advanced** menu and then press **Enter** or **▶**. Press **▼▲** to move up and down in the **Advanced** menu.

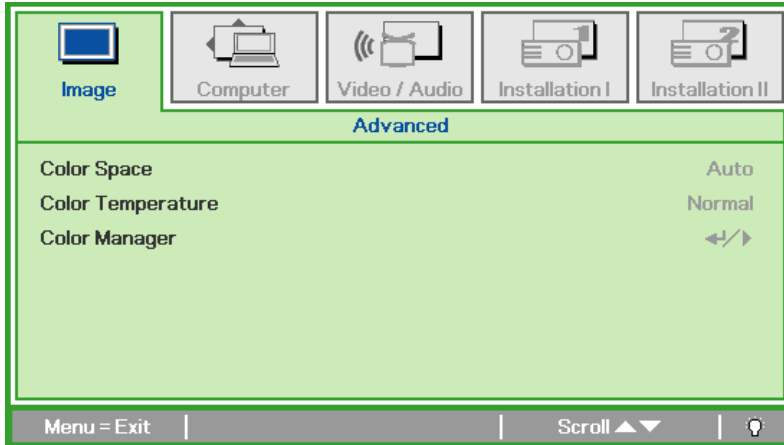

ITEM	DESCRIPTION
Color Space	Press the cursor <b>◀▶</b> button to adjust the color space.
Color Temperature	Press the cursor <b>◀▶</b> button to adjust the color temperature.
Color Manager	Press <b>◀</b> (Enter) / <b>▶</b> to enter the color manager menu. See page 23 for more information on <a href="#">Color Manager</a> .

ColorManager

Press ◀ (Enter) / ▶ to enter the **Color Manager** sub menu.

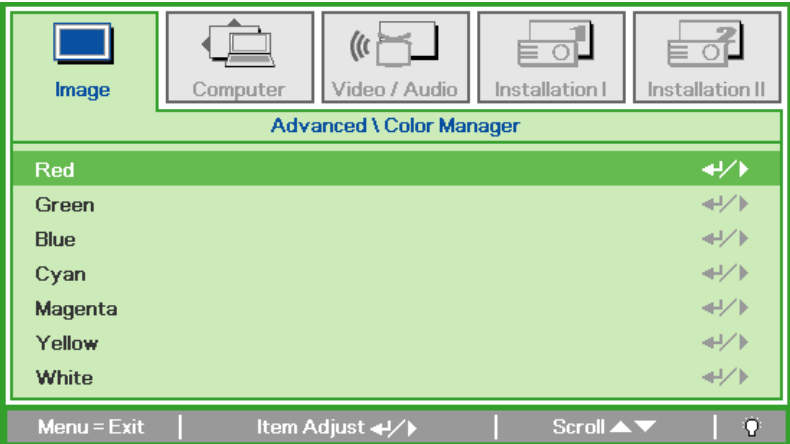

ITEM	DESCRIPTION
Red	Select to enter the Red Color Manager. Press the ◀▶ buttons to adjust the Hue, Saturation, and Gain.
Green	Select to enter the Green Color Manager. Press the ◀▶ buttons to adjust the Hue, Saturation, and Gain.
Blue	Select to enter the Blue Color Manager. Press the ◀▶ buttons to adjust the Hue, Saturation, and Gain.
Cyan	Select to enter the Cyan Color Manager. Press the ◀▶ buttons to adjust the Hue, Saturation, and Gain.
Magenta	Select to enter the Magenta Color Manager. Press the ◀▶ buttons to adjust the Hue, Saturation, and Gain.
Yellow	Select to enter the Yellow Color Manager. Press the ◀▶ buttons to adjust the Hue, Saturation, and Gain.
White	Select to enter the White Color Manager. Press the ◀▶ buttons to adjust the Red, Green, and Blue.



## Computer Menu

Press the **MENU** button to open the **OSD** menu. Press the cursor ◀▶ button to move to the **Computer** menu. Press the cursor ▲▼ button to move up and down in the computer menu. Press ◀▶ to change values for settings.

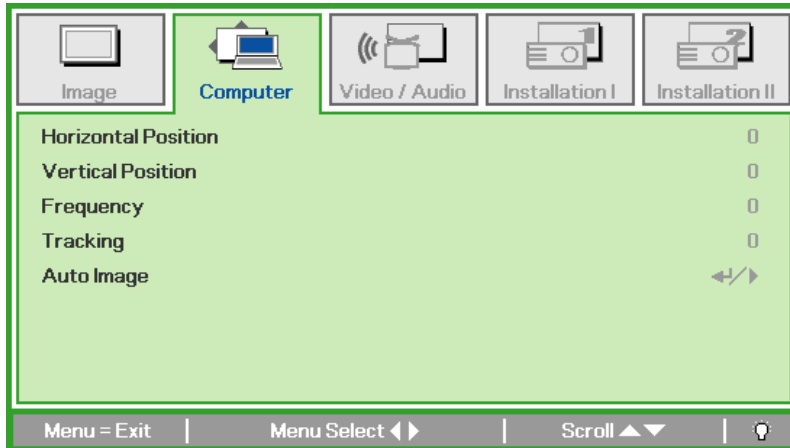

ITEM	DESCRIPTION
Horizontal Position	Press the cursor ◀▶ button to adjust the display position to left or right.
Vertical Position	Press the cursor ◀▶ button to adjust the display position to up or down.
Frequency	Press the cursor ◀▶ button to adjust the A/D sampling clock.
Tracking	Press the cursor ◀▶ button to adjust the A/D sampling dot.
Auto Image	Press ◀ (Enter) / ▶ to automatically adjustment for phase, tracking, size and position.

## Video/Audio Menu

Press the **MENU** button to open the **OSD** menu. Press the cursor ◀▶ button to move to the **Video/Audio** menu. Press the cursor ▲▼ button to move up and down in the **Video/Audio** menu. Press ◀▶ to change values for settings.

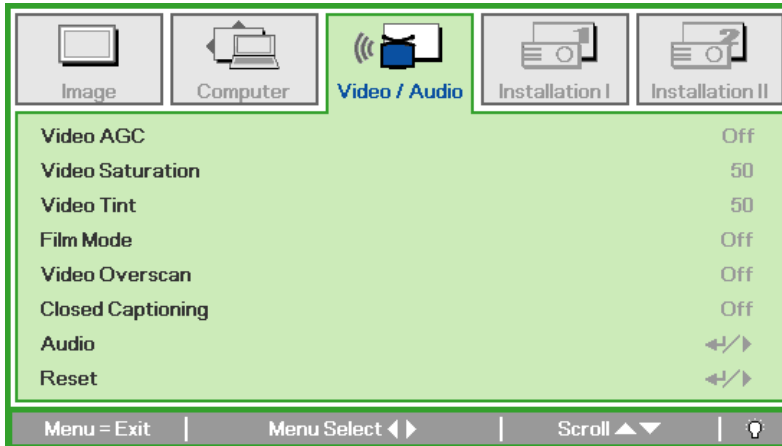

ITEM	DESCRIPTION
Video AGC	Press the ◀▶ buttons to enable or disable the Automatic Gain Control for video source.
Video Saturation	Press the ◀▶ buttons to adjust the video saturation.
Video Tint	Press the ◀▶ buttons to adjust the video tint/hue.
Film Mode	Press the ◀▶ buttons to select a different film mode.
Video Overscan	Press the ◀▶ buttons to enable or disable video over scan.
Closed Captioning	Press the ◀▶ buttons to enable or disable Closed Captioning
Audio	Press ◀ (Enter) / ▶ to enter the Audio menu. See <a href="#">Audio</a> on page 26.
Reset	Press ◀ (Enter) / ▶ to reset all settings to default values.

**Note:**

*Video jaggging may occur when playing interlace video. To overcome this issue, open the Video / Audio menu and adjust the Film Mode feature.*

## Audio

Press **↵** (Enter) / **▶** to enter the **Audio** sub menu.

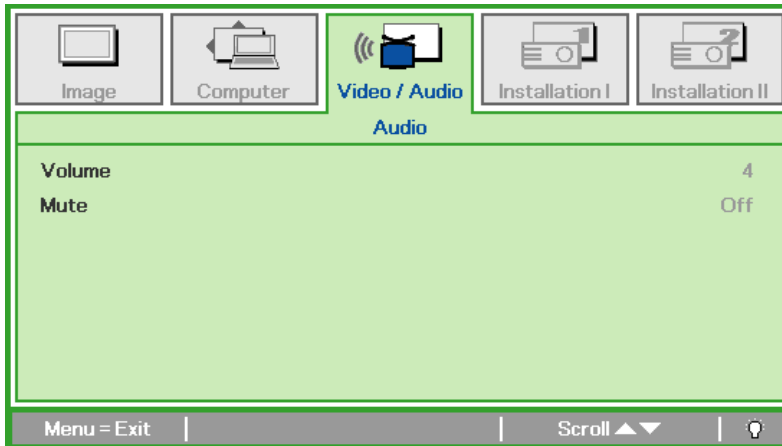

ITEM	DESCRIPTION
Volume	Press the ◀▶ buttons to adjust the audio volume.
Mute	Press the ◀▶ buttons to turn on or off the speaker.

## Installation I Menu

Press the **MENU** button to open the **OSD** menu. Press the cursor ◀▶ button to move to the **Installation I** menu. Press the cursor ▲▼ button to move up and down in the **Installation I** menu. Press ◀▶ to change values for settings.

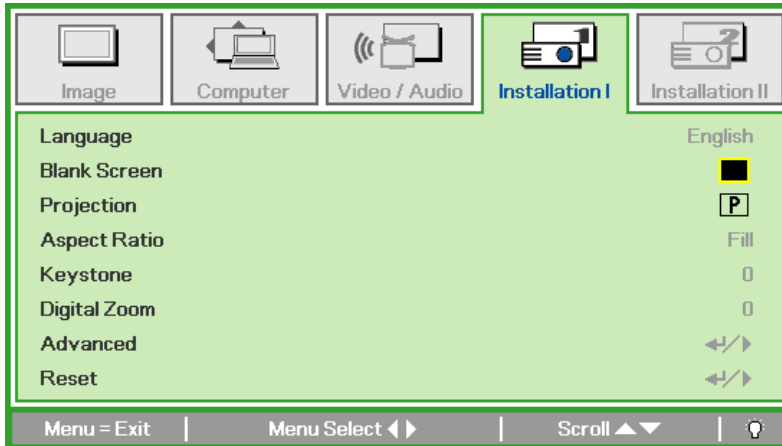

ITEM	DESCRIPTION
Language	Press the cursor ◀▶ button to select a different localization Menu.
Blank Screen	Press the cursor ◀▶ button to select different color to blank the screen.
Projection	Press the cursor ◀▶ button to choose from four projection methods:
Aspect Ratio	Press the cursor ◀▶ button to adjust the video aspect ratio.
Keystone	Press the cursor ◀▶ button to adjust the display keystone.
Digital Zoom	Press the cursor ◀▶ button to adjust the Digital Zoom menu.
Advanced	Press ◀ (Enter) / ▶ to enter the Advanced menu. See <a href="#">Advanced Feature</a> on page 30.
Reset	Press ◀ (Enter) / ▶ to reset all settings to default values (except Language and Security Lock).

### Advanced Feature

Press the **Menu** button to open the **OSD** menu. Press **◀▶** to move to the **Installation I** menu. Press **▲▼** to move to the **Advanced** menu and then press **Enter** or **▶**. Press **▲▼** to move up and down in the **Advanced** menu. Press **◀▶** to change values for setting.

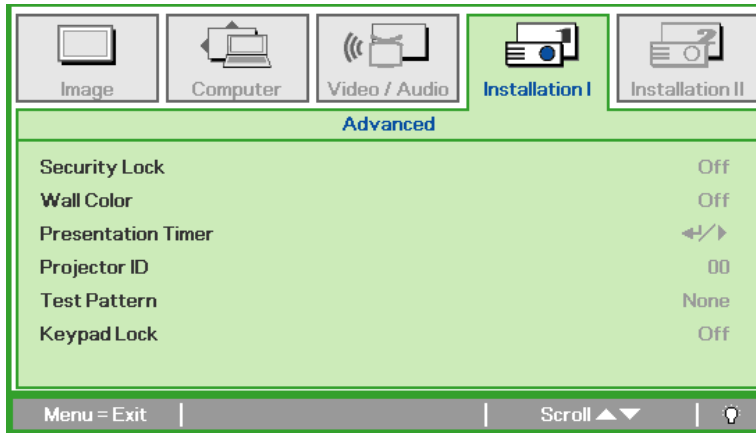

ITEM	DESCRIPTION
Security Lock	Press the cursor <b>◀▶</b> button to enable or disable security lock function.
Wall Color	Press the cursor <b>◀▶</b> button to select different wall color setting.
Presentation Timer	Press <b>◀</b> (Enter) / <b>▶</b> to enter the Presentation menu. See <a href="#">Advanced Feature</a> on page 28.
Projector ID	Press the cursor <b>◀▶</b> button to adjust a two digit projector ID from 0 through 98.
Test Pattern	Press the cursor <b>◀▶</b> button to select internal test pattern.
Keypad Lock	Press the cursor <b>◀▶</b> button to enable or disable keys can be work on keypad.

### Presentation Timer

The Presentation Timer function can indicate the presentation time on the screen to help you achieve better time management when giving presentations.

Press **◀** (Enter) / **▶** to enter the **Presentation Timer** sub menu.

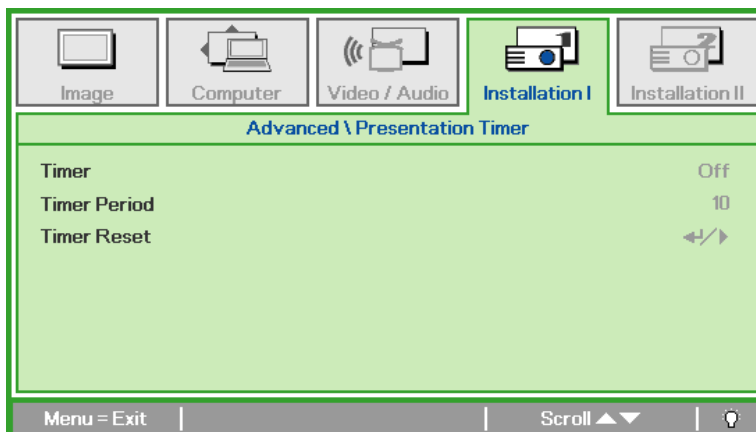

ITEM	DESCRIPTION
Timer	Press the cursor <b>◀▶</b> button to enable or disable presentation timer function.
Timer Period	Press the cursor <b>◀▶</b> button to adjust the display timer period.
Timer Reset	Press <b>◀</b> (Enter) / <b>▶</b> to reset presentation timer counter.

## Installation II Menu

Press the **MENU** button to open the **OSD** menu. Press the cursor ◀▶ button to move to the **Installation II** menu. Press the cursor ▲▼ button to move up and down in the Installation II menu.

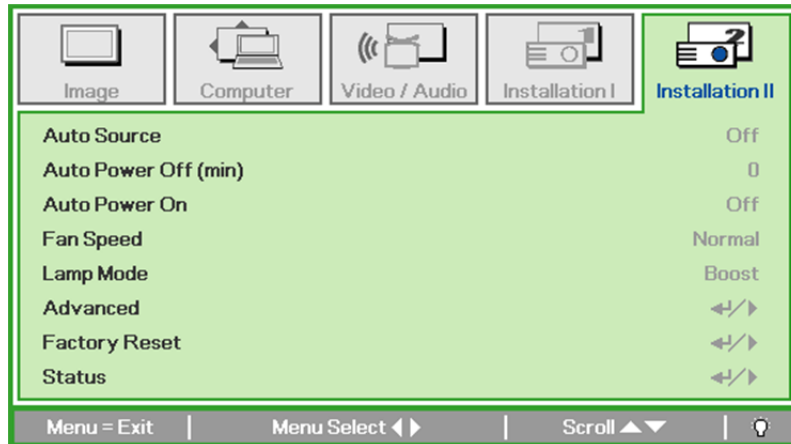

ITEM	DESCRIPTION
Auto Source	Press the cursor ◀▶ button to enable or disable automatic source detection.
Auto Power Off (min.)	Press the cursor ◀▶ button to enable or disable automatic shutdown of lamp when no signal.
Auto Power On	Press the cursor ◀▶ button to enable or disable automatic power On when AC power is supplied.
Fan Speed	Press the cursor ◀▶ button to toggle between Normal and High fan speeds. <b>Note:</b> We recommend selecting high speed in high temperatures, high humidity, or high altitude (higher than 1500m/4921ft) areas.
Lamp Mode	Press the cursor ◀▶ button to select the lamp mode for higher brightness or lower brightness to save lamp life.
Advanced	Press ◀ (Enter) / ▶ to enter the Advanced menu. See <a href="#">Advanced Feature</a> on page 30.
Factory Reset	Press ◀ (Enter) / ▶ to reset all items to factory preset values.
Status	Press ◀ (Enter) / ▶ to enter the Status menu. See page 39 for more information on <a href="#">Status</a> .

### Advanced Feature

Press the **Menu** button to open the **OSD** menu. Press **◀▶** to move to the **Installation II** menu. Press **▲▼** to move to the **Advanced** menu and then press **Enter** or **▶**. Press **▲▼** to move up and down in the **Advanced** menu. Press **◀▶** to change values for setting.

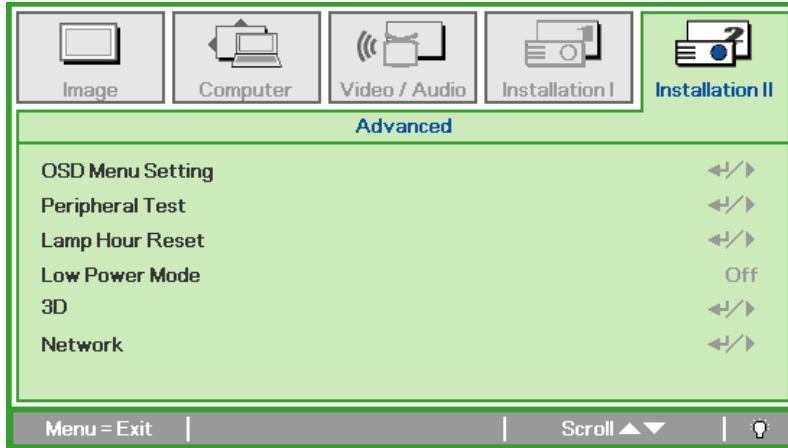

ITEM	DESCRIPTION
OSD Menu Setting	Press Enter / ▶ to enter the OSD setting menu. See page 31 for more information on <a href="#">OSD Menu Setting</a> .
Peripheral Test	Press Enter/ ▶ to enter the Peripheral Test menu. See page 31 for more information on <a href="#">Peripheral Test</a> .
Lamp Hour Reset	After replacing the lamp, this item should be reset. See page 32 for more information on <a href="#">Lamp Hour Reset</a> .
Low Power Mode	Press ◀▶ to turn Low Power Mode on or off.
3D	Press ◀Enter/ ▶ to enter the 3D menu. See page 33 for more information on <a href="#">3D</a> setting..
Network	Press ◀ (Enter) / ▶ to enter the Network menu. See page 34 for more information on <a href="#">Network</a> .

**Note:**

To enjoy the 3D function, first enable the Play Movie in 3D setting found in your DVD device under the 3D Disc Menu.

OSD Menu Setting

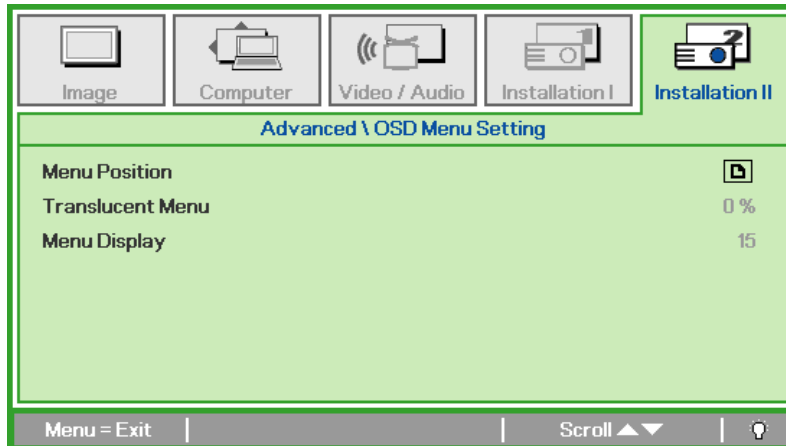

ITEM	DESCRIPTION
Menu Position	Press ◀▶ button to select different OSD location.
Translucent Menu	Press ◀▶ button to select OSD background translucent level.
Menu Display	Press ◀▶ button to select OSD timeout delay.

Peripheral Test

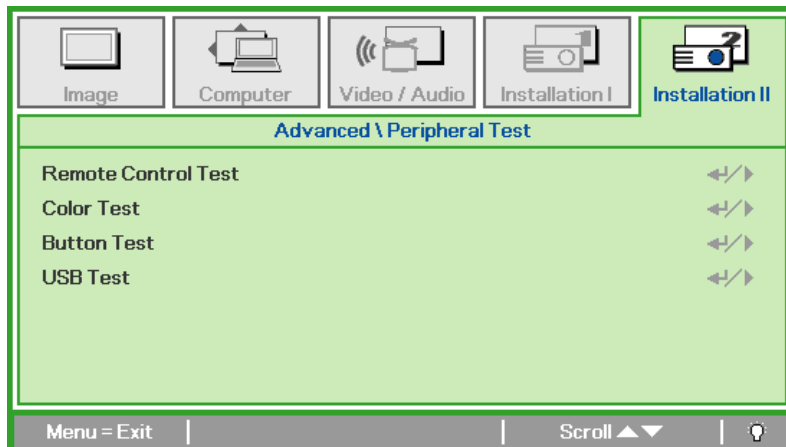

ITEM	DESCRIPTION
Remote Control Test	Press ◀ (Enter) / ▶ to test the IR remote controller for diagnostic.
Color Test	Press ◀ (Enter) / ▶ to select different colors on screen.
Button Test	Press ◀ (Enter) / ▶ to test the button on keypad.
USB Test	Press ◀ (Enter) / ▶ to test the USB connection with connected PC.



Lamp Hour Reset

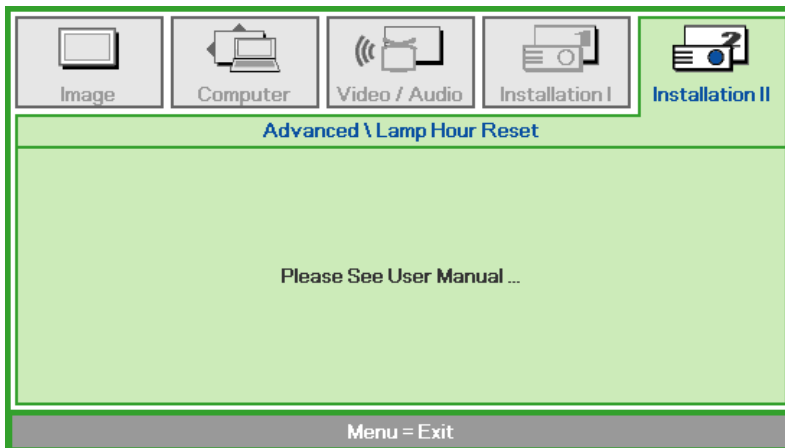

Please refer to [Resetting the Lamp](#) on page 65 to reset the lamp hour counter.

3D

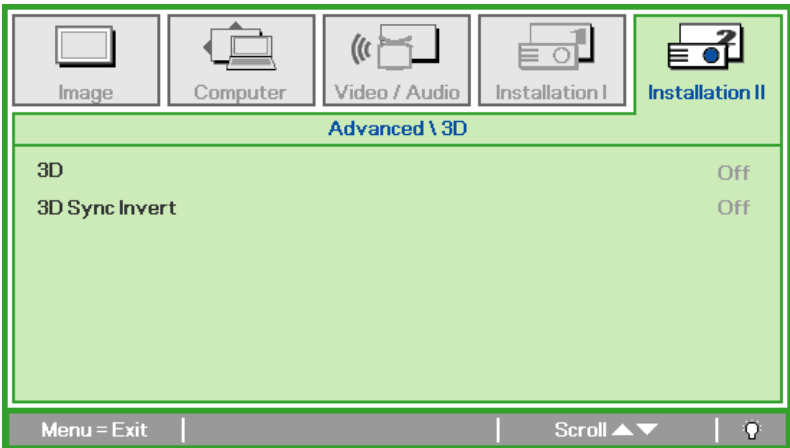

ITEM	DESCRIPTION
3D	Press the cursor ◀▶ button to select different 3D mode.
3D Sync Invert	Press the cursor ◀▶ button to enable or disable 3D Sync Invert.

**Note:**

1. The 3D OSD menu item is gray if there is no appropriate 3D source. This is the default setting.
2. When the projector is connected to an appropriate 3D source, the 3D OSD menu item is enabled for selection.
3. Use 3D glasses to view a 3D image.
4. You need 3D content from a 3D DVD or 3D media file.
5. You need to enable the 3D source (some 3D DVD content may have a 3D on-off selection feature).
6. You need DLP link 3D or IR 3D shutter glasses. With IR 3D shutter glasses, you need to install a driver on your PC and connect a USB emitter.
7. The 3D mode of the OSD needs to match the type of glasses (DLP link or IR 3D).
8. Power on the glasses. Glasses normally have a power on -off switch. Each type of glasses has their own configuration instructions. Please follow the configuration instructions that come with your glasses to finish the setup process.

**Note:**  
 Since different types of glass (DLP link or IR shutter glass) have their own setting instructions, Please follow the guide to finish the setup process.

Network

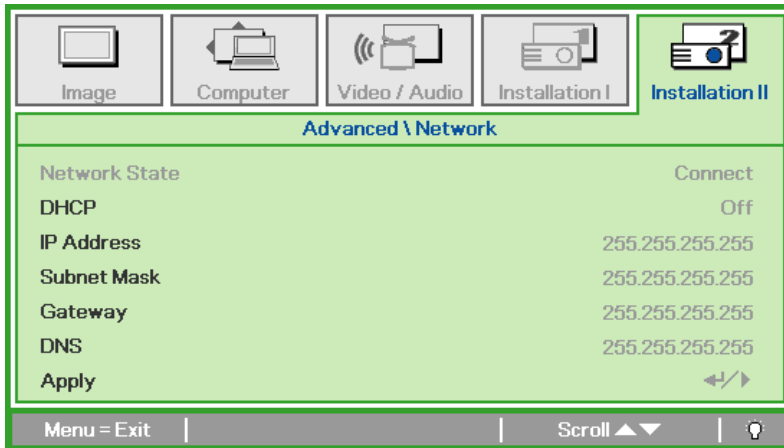

ITEM	DESCRIPTION
Network State	Displays the network connection status.
DHCP	Press ◀▶ to turn DHCP On or Off. <b>Note:</b> If you select DHCP Off, complete the IP Address, Subnet Mask, Gateway, and DNS fields.
IP Address	Enter a valid IP address if DHCP is turned off.
Subnet Mask	Enter a valid Subnet Mask if DHCP is turned off.
Gateway	Enter a valid Gateway address if DHCP is turned off.
DNS	Enter a valid DNS name if DHCP is turned off.
Apply	Press ◀ (Enter) / ▶ to confirm settings.

For simplicity and ease of operation, the projector provides diverse networking and remote management features.

The LAN/RJ45 function of the projector through a network, such as remotely manage: Power On/Off, Brightness and Contrast settings. Also, projector status information, such as: Video-Source, Sound-Mute, etc.

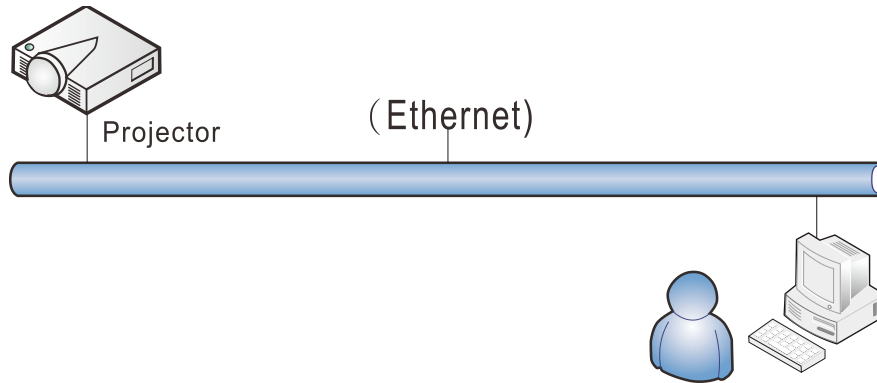

### LAN\_RJ45

1. Connect an RJ45 cable to RJ45 ports on the projector and the PC (Laptop).

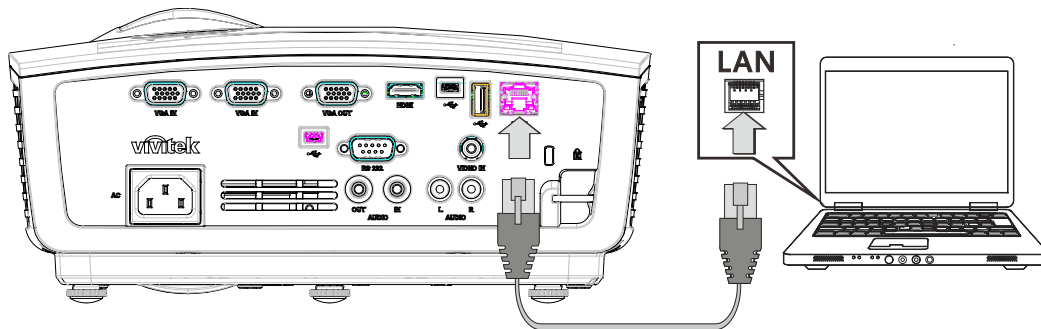

2. On the PC (Laptop), select **Start** → **Control Panel** → **Network Connections**.

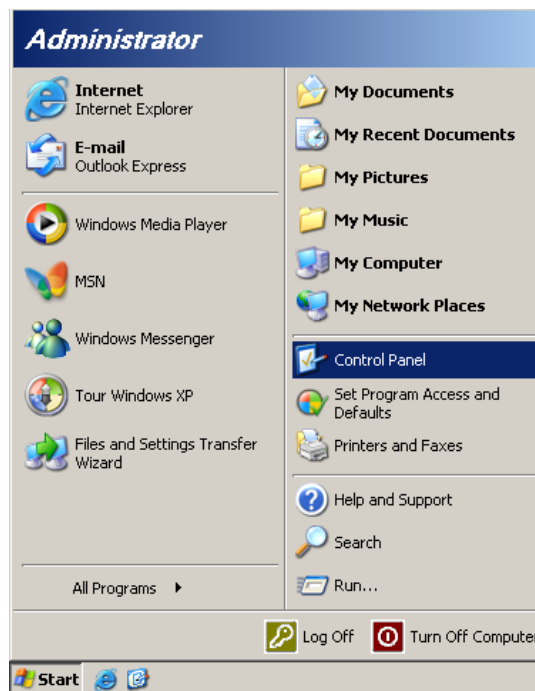

3. Right-click on **Local Area Connection**, and select **Properties**.

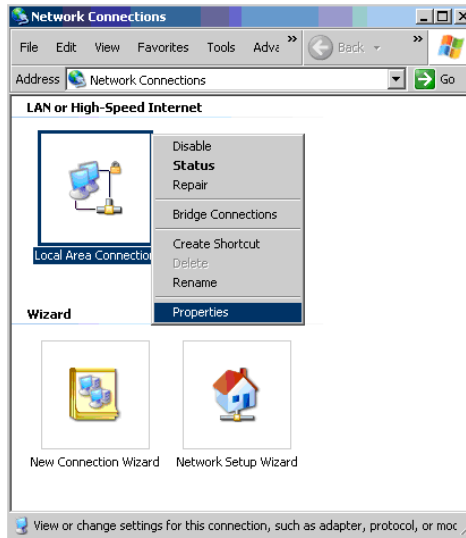

4. In the **Properties** window, select the **General** tab, and select **Internet Protocol (TCP/IP)**.
5. Click **Properties**.

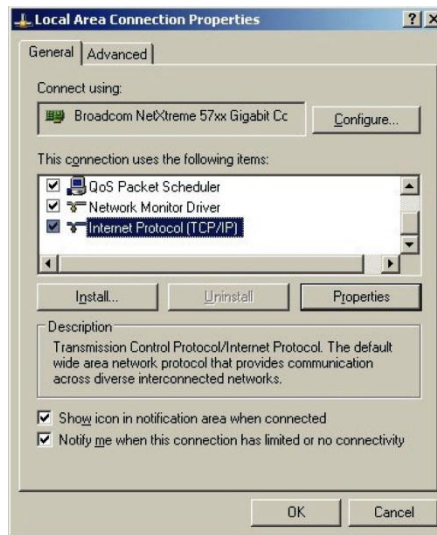

6. Click **Use the following IP address** and fill in the IP address and Subnet mask, then click **OK**.

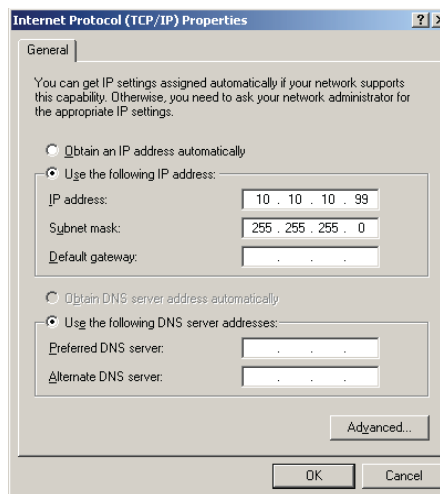

7. Press the **Menu** button on the projector.
8. Select **Installation II** → **Advanced** → **Network**.
9. After getting into **Network**, input the following:
  - ▶ DHCP: Off
  - ▶ IP Address: 10.10.10.10
  - ▶ Subnet Mask: 255.255.255.0
  - ▶ Gateway: 0.0.0.0
  - ▶ DNS Server: 0.0.0.0
10. Press **↵** (Enter) / **▶** to confirm settings.

Open a web browser  
 (for example, Microsoft Internet Explorer with Adobe Flash Player 9.0 or higher).

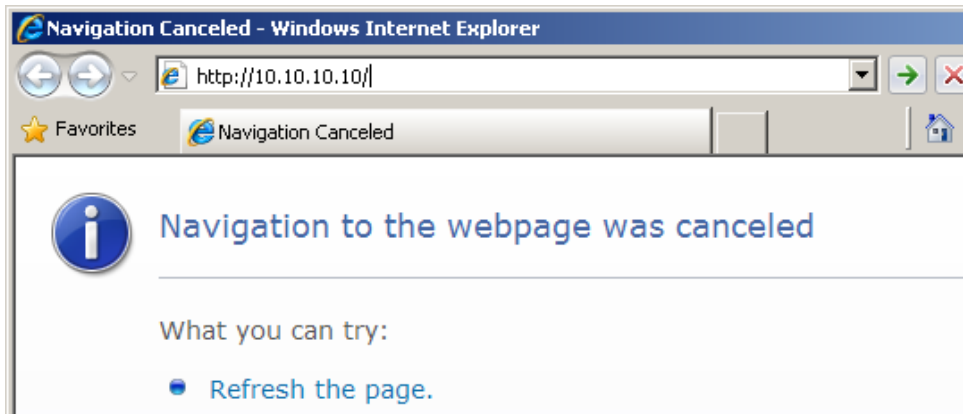

11. In the Address bar, input the IP address: 10.10.10.10.
12. Press **↵** (Enter) / **▶**.

The projector is setup for remote management. The LAN/RJ45 function displays as follows.



Expansion Options

The screenshot shows a configuration interface with the following sections:

- Crestron Control:** IP Address, IP ID, Control Port, and a 'Control Set' button.
- Projector:** Projector Name (PJ01), Location (RM01), Assigned To (Sir), and a 'Set' button.
- Network Config:** DHCP Enabled (checkbox), IP Address (10.10.10.10), Subnet Mask (255.255.255.0), Default Gateway (0.0.0.0), DNS Server (0.0.0.0), and a 'Net Set' button.
- User Password:** Usr Enabled (checkbox), Password, Confirmed, and a 'Usr Set' button.
- Admin Password:** Adm Enabled (checkbox), Password, Confirmed, and an 'Adm Set' button.

A 'Tools Exit' button is located at the bottom center.

CATEGORY	ITEM	INPUT-LENGTH
Crestron Control	IP Address	14
	IP ID	3
	Port	5
Projector	Projector Name	10
	Location	10
	Assigned To	10
Network Configuration	DHCP (Enabled)	(N/A)
	IP Address	15
	Subnet Mask	15
	Default Gateway	15
	DNS Server	15
User Password	Enabled	(N/A)
	New Password	15
	Confirm	15
Admin Password	Enabled	(N/A)
	New Password	15
	Confirm	15

For more information, please visit <http://www.crestron.com>.

**Factory Reset**

Press the cursor ▲▼ button to move up and down in the **Installation II** menu. Select the **Factory Reset** sub menu and press ← (Enter) / → to reset all the menu items to the factory default values (except Language and Security Lock).

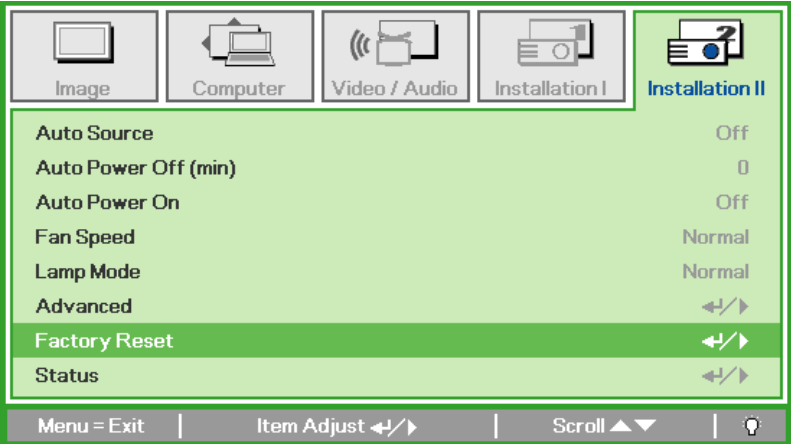

**Status**

Press the cursor ▲▼ button to move up and down in the **Installation II** menu. Select the **Installation II** sub menu and press ← (Enter) / → to enter the **Status** sub menu.

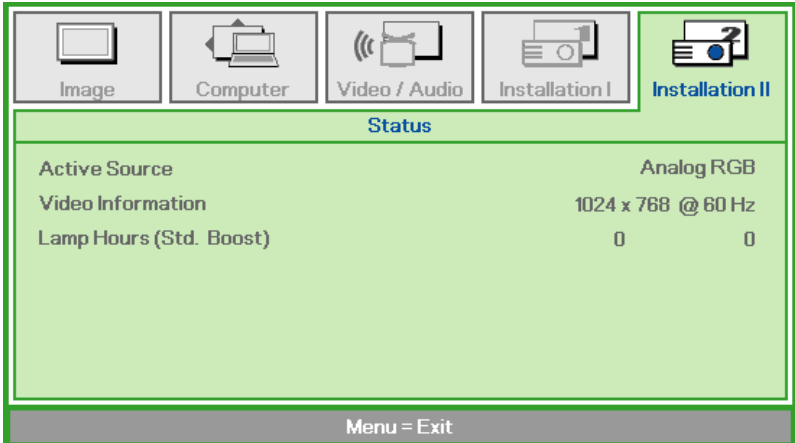

ITEM	DESCRIPTION
Active Source	Display the activated source.
Video Information	Displays resolution/video information for RGB source and color standard for Video source.
Lamp Hours	Lamp hour used information is displayed. ( Std. and Boost )



## **Features**

The Multi-Media software is designed to provide exceptional display performance from a USB drive, the projector's internal memory or network (LAN/WiFi) connection. The plug-and-play USB feature allows you to project content without needing a PC. Additionally, you can transfer files to the projector's on-board memory storage for greater portability.

## **Media Menu**

The Multi-Media utility allows for the display of the following through your desktop:

- Display movies
- Play audio files
- View photos
- Display documents

## Media

The media player makes it convenient and easy to play audio, video, images and view documents by directly inserting a USB device into the projector or by accessing the projector's internal memory.

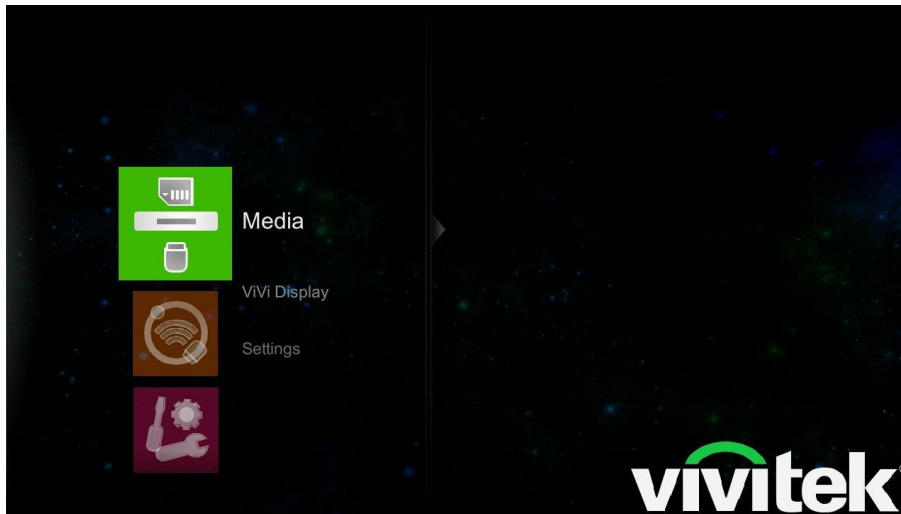

ITEM	DESCRIPTION
Photo	Allows you to display photos and provides slideshow functionality. Supported formats: JPEG, JPG, and BMP
Movie	Allows you to play movie files. Supported formats: AVI, MKV, TS, DAT, VOD, MPG, MPEG, MOV, MP4, and WMV.
Music	Allows you to play audio files. Supported formats: MP1, MP2, MP3, WMA, OGG, ADPCM-WAV, PCM-WAV, and AAC.
Office Viewer	Allows you to display document files. Supported formats: Microsoft® Word 97-2007 (DOC), PowerPoint 97-2007 (PPT), and Excel 97-2007 (XLS); Adobe® Acrobat Reader (PDF); text files (TXT).

## Vivi Display

ViVi Display provides easier PC to projector interactivity to enhance your multimedia experience. Through the use of this tool, you can project your PC desktop on the screen via a LAN or WiFi connection.

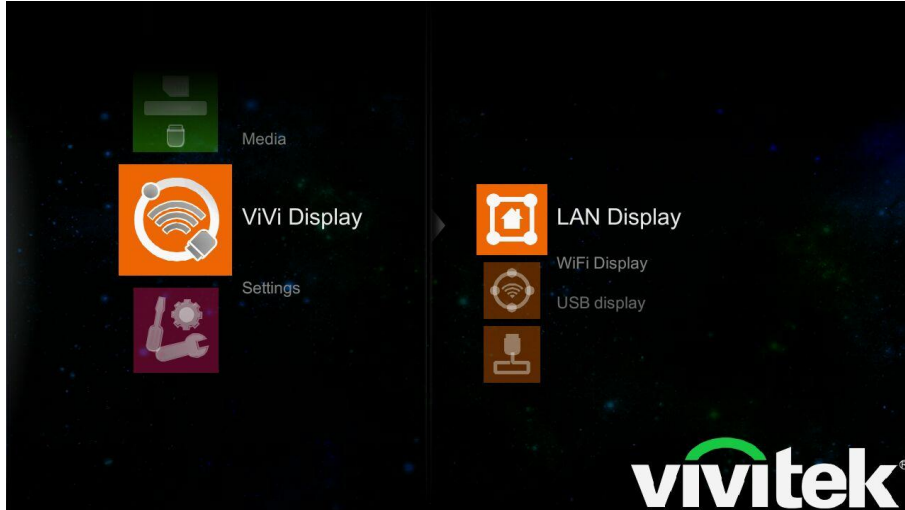

ITEM	DESCRIPTION
LAN Display	Connect your projector to a network. The LAN Display function allows you to display your PC's screen through the LAN.
Wifi Display	The projector broadcasts an SSID which allows you to connect to your PC. The PC's screen can be projected using ViVi Display through the WiFi.
USB Display	Connect your projector to a PC through a USB cable. The PC's screen can be projected using ViVi Display through the WiFi.

## Settings

The Settings menu allows for the configuration and settings changes for the system, video, photo, and audio functions on the projector.

### System

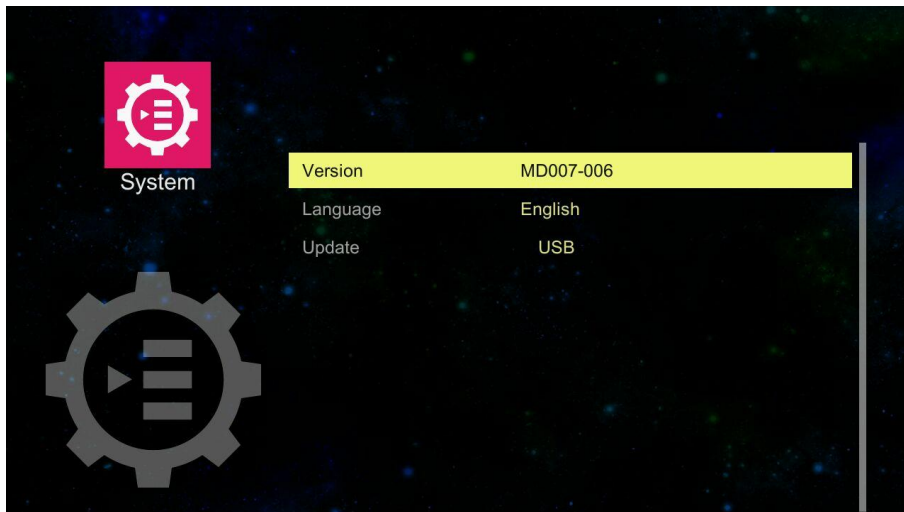

ITEM	DESCRIPTION
Version	Media software version. Information only.
Language	Press ◀ and press ▲ ▼ to make desire language in the center of menu.
Update	Upgrade media software.

### Video

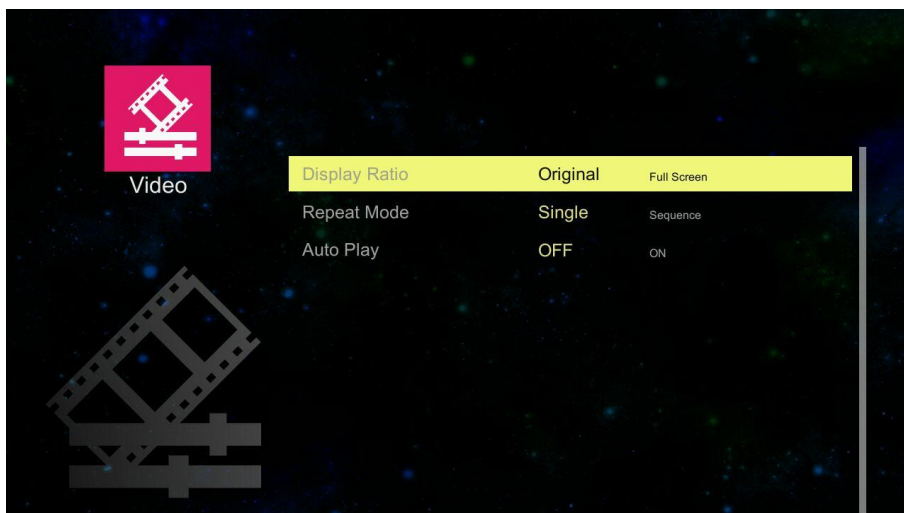

ITEM	DESCRIPTION
Display Ratio	Press ◀▶ to set the display ratio of Video.
Repeat Mode	Press ◀▶ to set repeat mode.
Auto Play	Press ◀▶ to turn on or off automatic play when powered on.

## Photo



ITEM	DESCRIPTION
Display Ratio	Press <b>←</b> and press <b>▲ ▼</b> to set the display ratio of Photo.
Slideshow	Press <b>◀▶</b> to enable or disable slideshow when playing photos.
Slideshow Duration	Press <b>←</b> and press <b>▲ ▼</b> to set time interval of slideshow.

## Audio

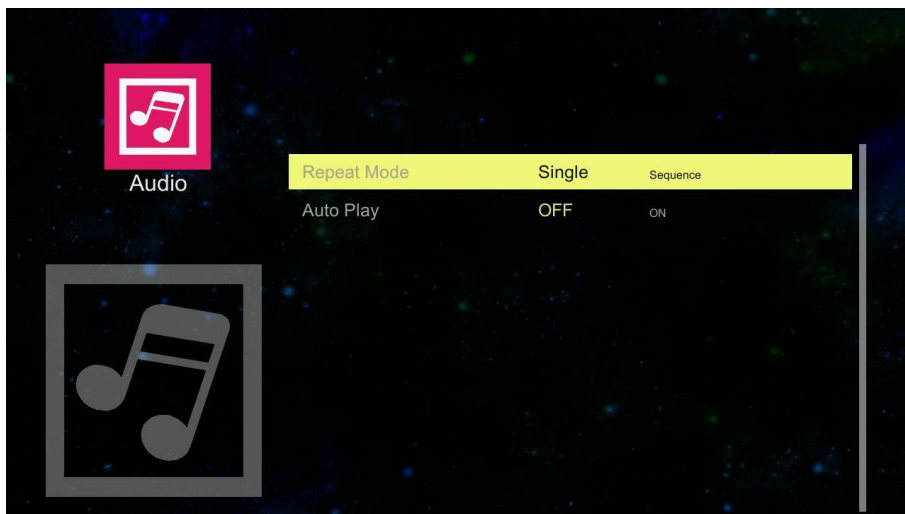

ITEM	DESCRIPTION
Repeat Mode	Press <b>◀▶</b> to set repeat mode.
Auto Play	Press <b>◀▶</b> to turn on or off automatic play when powered on.

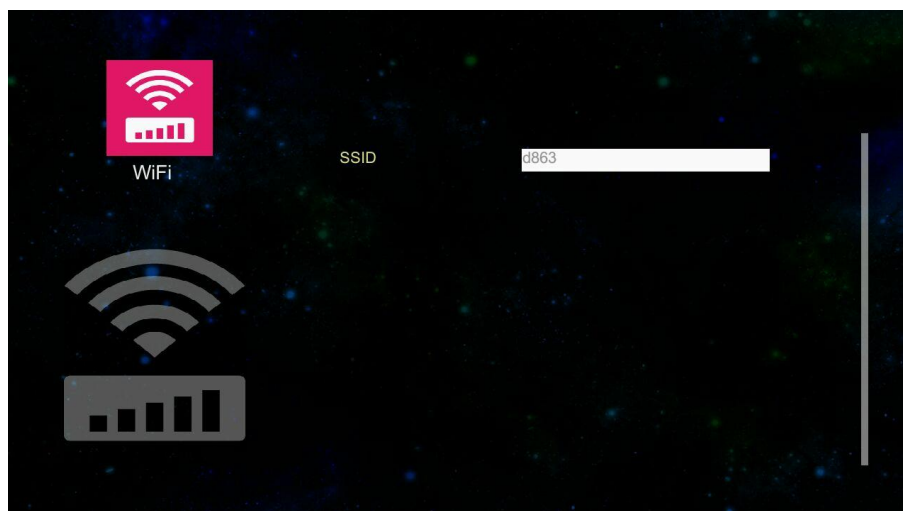
Wifi

ITEM	DESCRIPTION
SSID	Press <b>←</b> and press <b>▲ ▼ ◀ ▶</b> .to set the SSID. Press <b>Auto</b> to exit the setting screen.

### Installing ViVi Display

Before you can begin using the Multi-Media utility, you will need to install the utility for the first time on your PC. Follow the on-screen instructions to install. Once installed the Multimedia utility icon is available on your PC to access the utility.

#### ViVi Display requirement

<b>CPU</b>	Intel/AMD Dual Core 2 GHz or higher (ATOM not supported)
<b>GRAPHIC CARD</b>	Intel, nVIDIA or AMD graphic card with 64MB VRAM or above
<b>OPERATING SYSTEM</b>	Windows XP Professional SP3, Vista SP3, Windows 7 SP2
<b>DRAM</b>	1GB DDR
<b>WiFi</b>	802.11n

**Note:**

*Administrator rights on the PC are required to install the software.*

**To install the utility:**

Connect a USB (Type-A) to the PC and the other end (USB Mini A) to the projector.

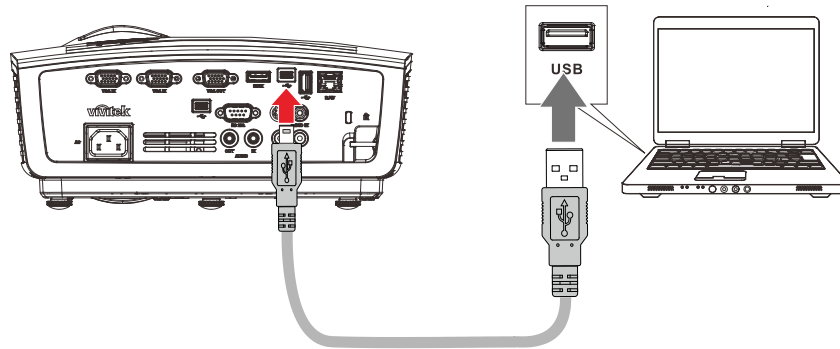

Click Start -> Computer\* to open an explorer window.

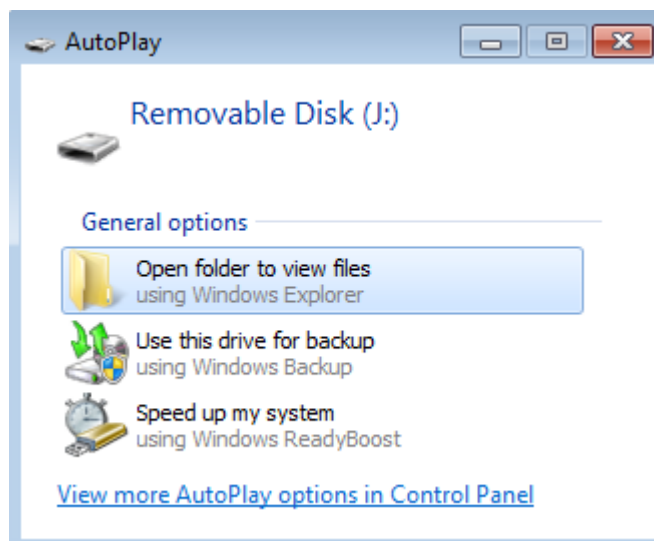

Three **Removable Disks** are created. Search for the file **ViviDisplay.exe**. Click **ViviDisplay.exe** to install.

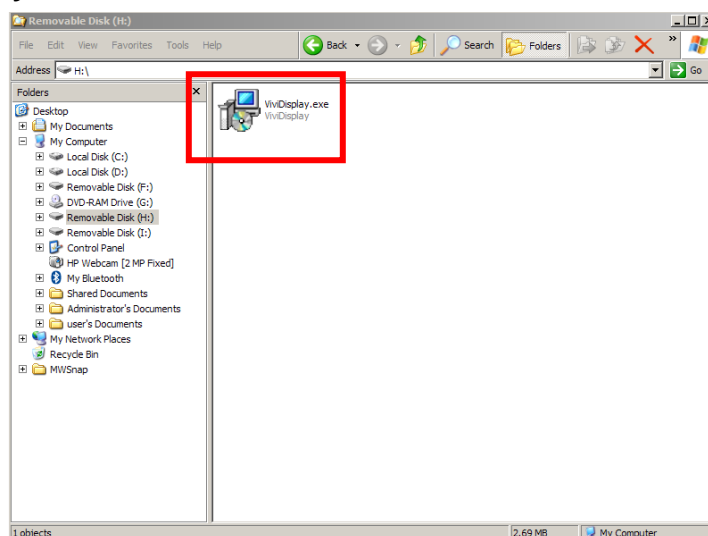

\*The terminology may differ between operating systems.



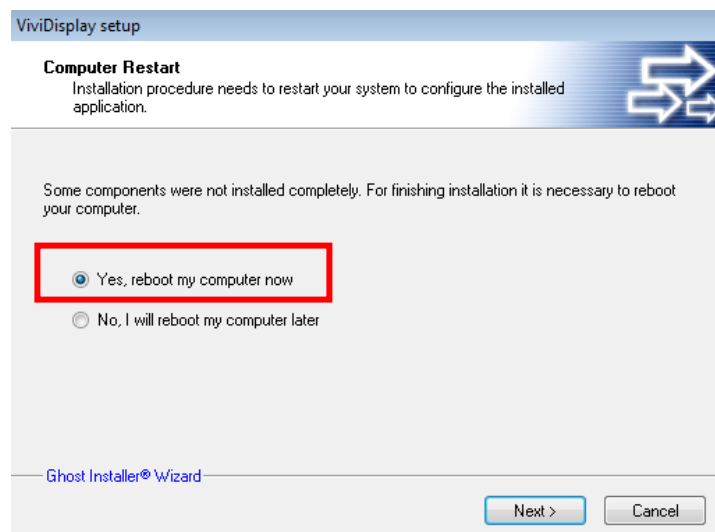
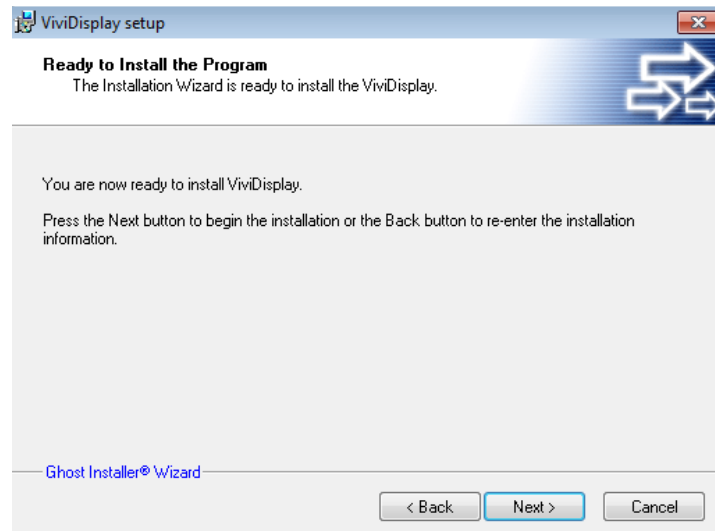

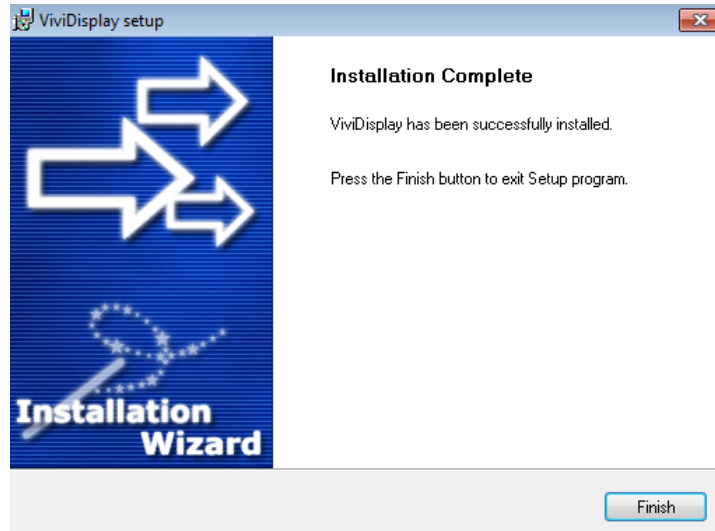

EZ Wifi icon will display on your desktop after Vividisplay Installation Complete



## Making Connections

### LAN Connection

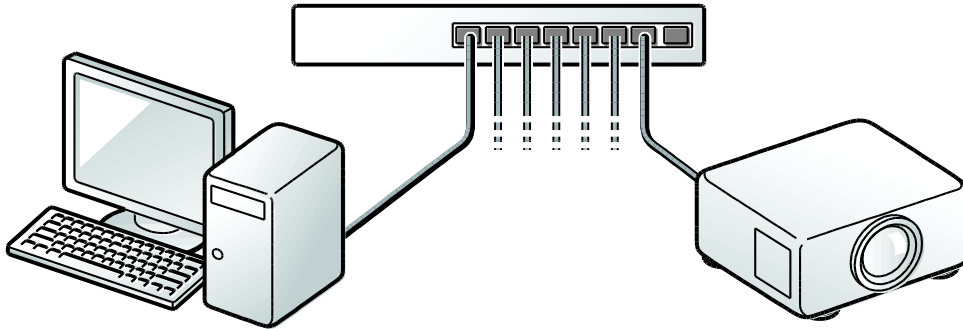

Connect the projector to a LAN cable.

Press **MENU** on remote control.

Select **Installation II** -> **Advanced** -> **Network** to configure your network.

(Set DHCP to On)

Use the remote control and select **Multi Media** -> **ViVi Display** -> **LAN Display**.

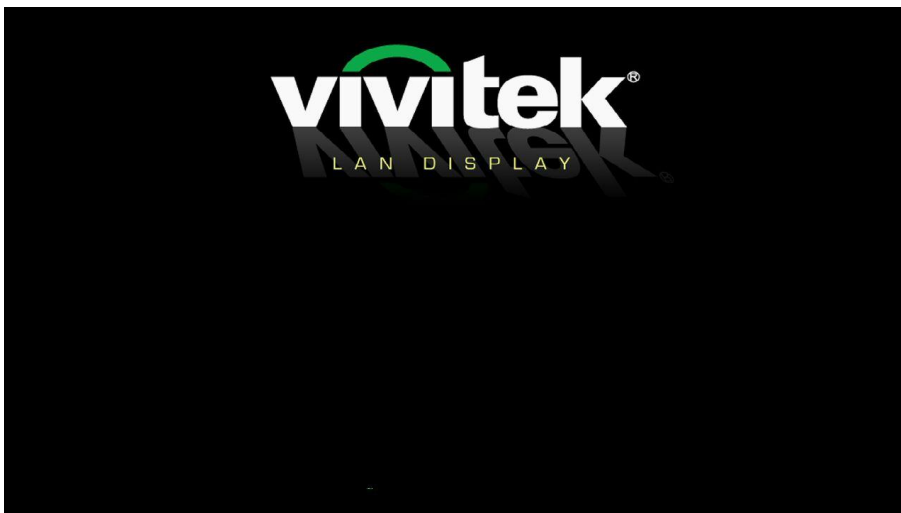

Click EZ Wifi icon on your desktop and launch ViViDisplay. It starts LAN Display if the projector's IP is correctly.



Click **Mirror** or **Extension** to display your desktop.

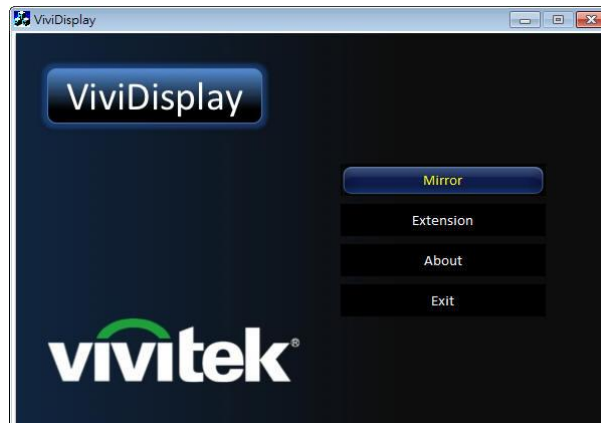

Press **Auto** to stop display.

**Note:**  
Use a category 5 or higher LAN cable.

## WiFi Connecting

Power on the projector and wait for the splash screen to display.

Insert a Vivitek wireless dongle into the projector.

Use the remote control and select **Multi Media -> ViVi Display ->Wifi Display**.

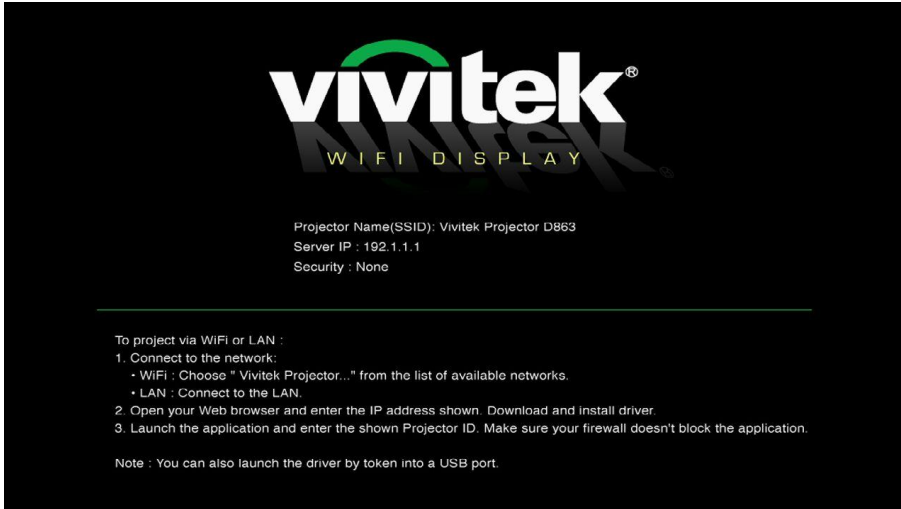

**Note:**

Your computer must have a wireless network adapter and driver installed and the adapter is enabled.

In the Toolbar (lower right corner), click to open the icons menu.

Select the wireless network  and click to open.

In the list of available wireless networks, click **AP Name** (Default: d863) and then click **Connect**.

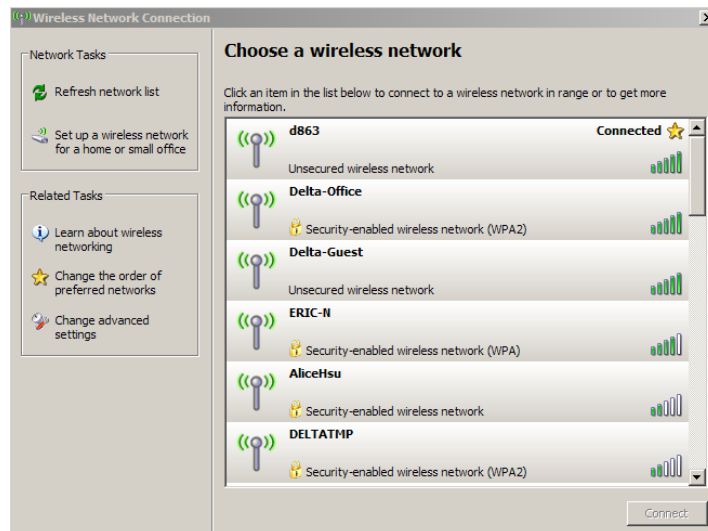

**Note:**

Select **Setting -> Wifi -> SSID** to change AP name. ( No more than 15 characters )

Click EZ Wifi icon on your desktop and launch ViViDisplay.

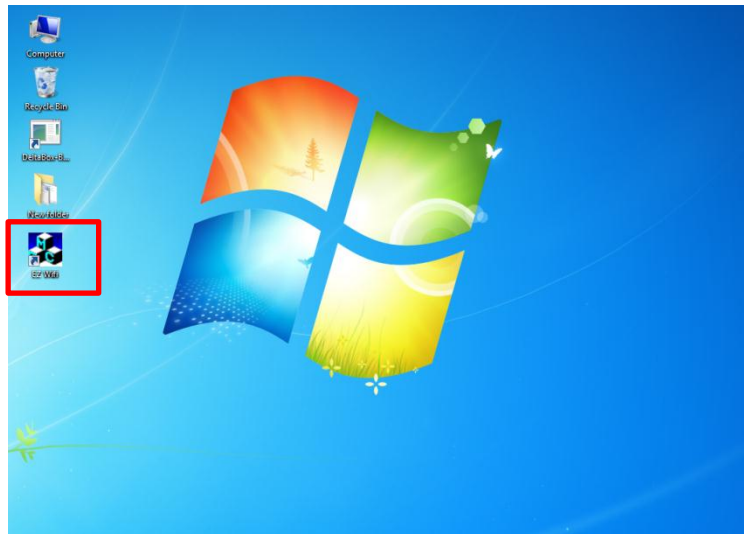

Click **Mirror** or **Extension** to display your desktop.

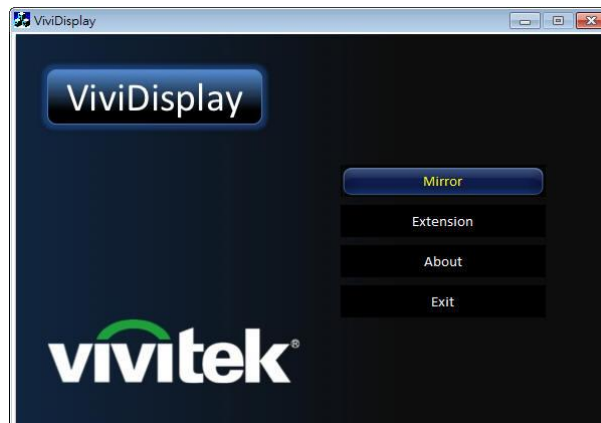

Press **Auto** to stop display.

**Note:**

1. *Mirror synchronizes as the main monitor, while Extension allows the projector to function as monitor two.*
2. *PC monitor resolution changes to 800x600 during ViViDisplay function usage.*
3. *PC monitor resolution changes back to original setting after exiting ViViDisplay usage.*

## Connecting a USB Device

Power on the projector.

Select **Multi Media** -> **ViVi Display** -> **USB Display**.

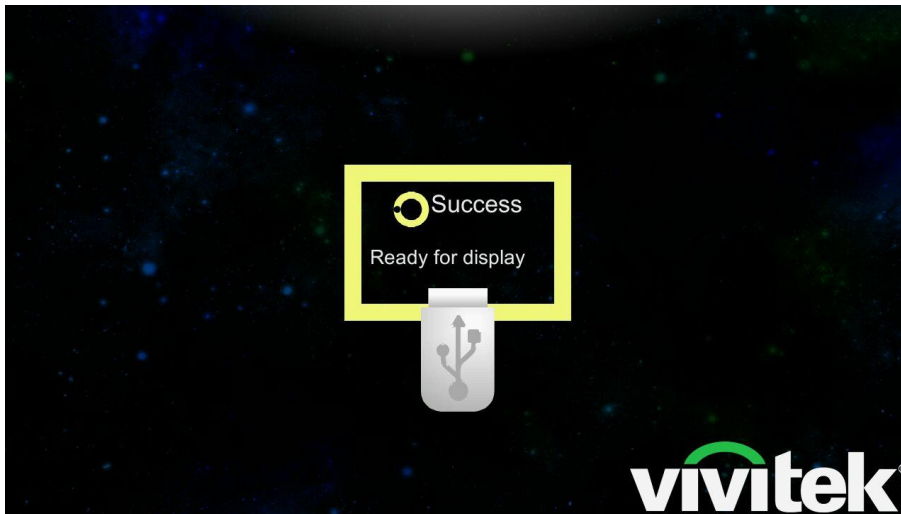

Insert the other end of the USB cable (Type A) into the target PC.

Insert a USB cable (Mini interface) into the back panel of the projector.

The USB device is detected on the PC.

For first time connections, the driver is installed automatically. (Or click EZ Display for installed manually.)

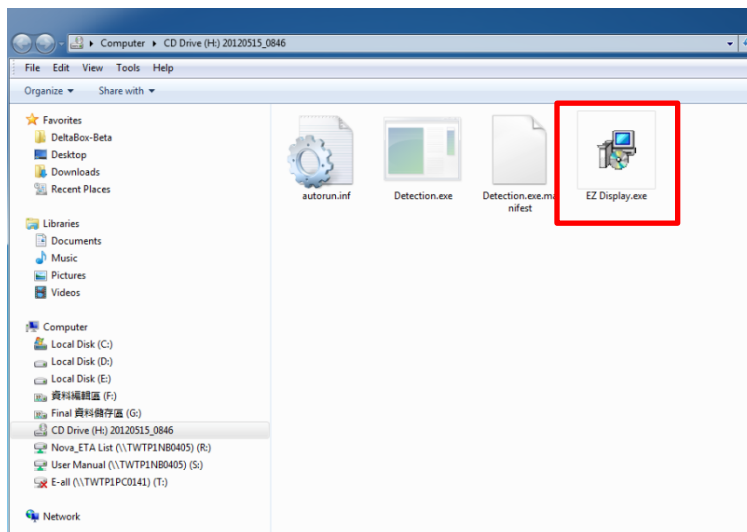

Follow the on-screen prompts to install the driver.

Open an Explorer window, select **My Computer\*** and click **EZ Display** to access the projector.

Click **EZ Display** in your desktop to display through USB.



Unplug USB cable to stop display.

\*May vary between operating systems.



## Display Media

You can view your media by directly inserting a USB device in the projector. The functions, as described in the following, are available for direct view.

### Viewing Photos

When a USB storage drive is inserted, the storage card folder icon displays in the file directory.

To open a photo in photo viewer, perform the following:

Press ▲ ▼ to select **Media** and then press ←.

Press ▲ ▼ to select **Internal Memory** or **USB** and then press ←.

Press ▲ ▼ to select **Photo** and then press ← to open file directory.

Select the file that you desire to display.

Press ← to display the photo.

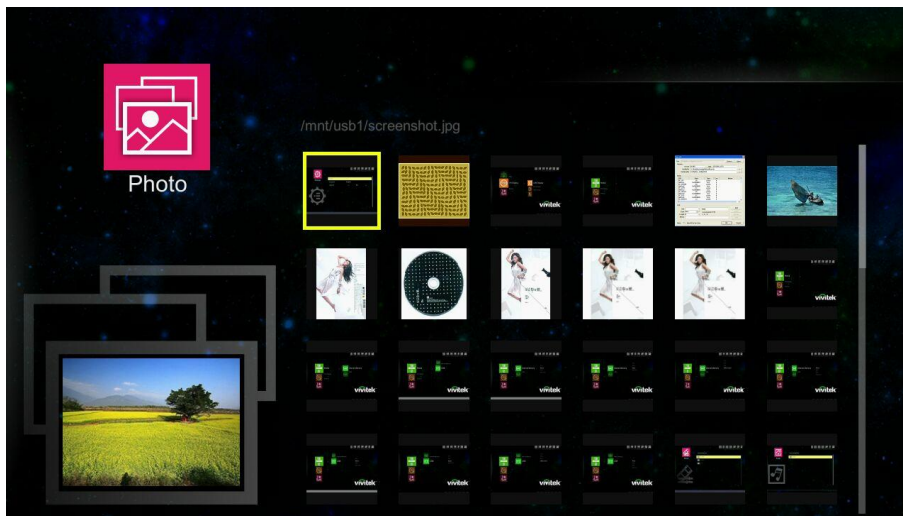

### Control Interface

◀: Play previous file

▶: Play next file

⏪: Play a file / Slideshow

**Auto:** Return to **Multi Media** menu.

## Viewing Movies

To view a movie file, perform the following:

Press ▲ ▼ to select **Media** and then press ↵.

Press ▲ ▼ to select **Internal Memory** or **USB** and then press ↵.

Press ▲ ▼ to select **Movie** and then press ↵ to open file directory.

Select the folder containing the desired movie file.

Press ↵ to play the desired movie file.

While a movie is playing, the control interface is automatically hidden. To play previous or view the next item on the list, press ◀ or ▶.

Press ↵ to pause a movie - the control interface displays.

Press ◀ or ▶ button can fast forward or backward while interface is show.

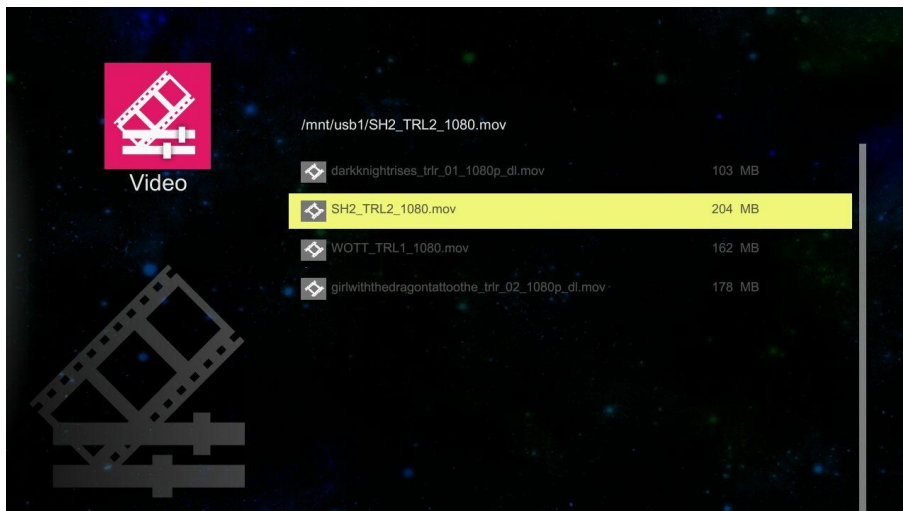

## Control Interface

◀: Play previous file

▶: Play next file

↵: Play a file / Pause and show the control interface

**Auto:** Return to **Multi Media** menu.

## Music

To open the music list, perform the following:

Press ▲ ▼ to select **Media** and then press ←.

Press ▲ ▼ to select **Internal Memory** or **USB** and then press ←.

Press ▲ ▼ to select **Music** and then press ← to open file directory.

Select the folder containing the desired audio file.

Press ← to play.

To pause or play an audio file, select the Pause/Play button in the music player interface.

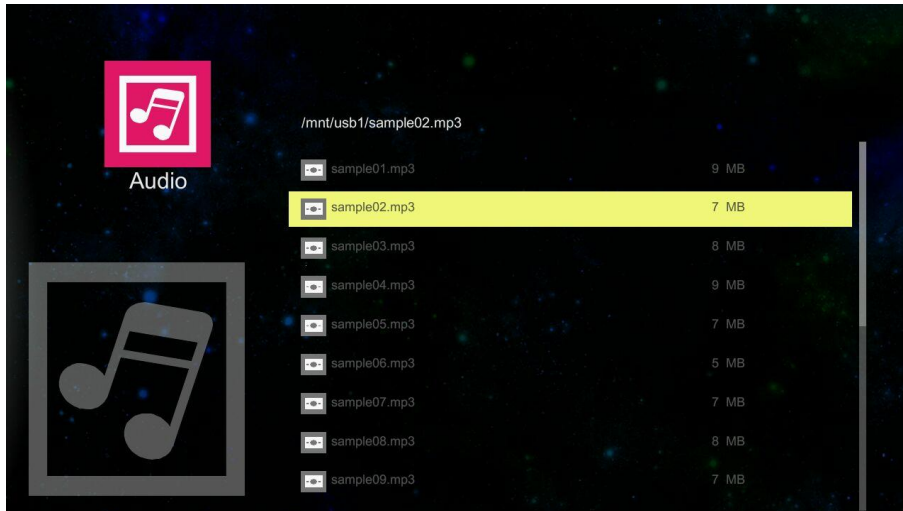

Control Interface

After select an audio, control interface will come up. The icon functions as following:

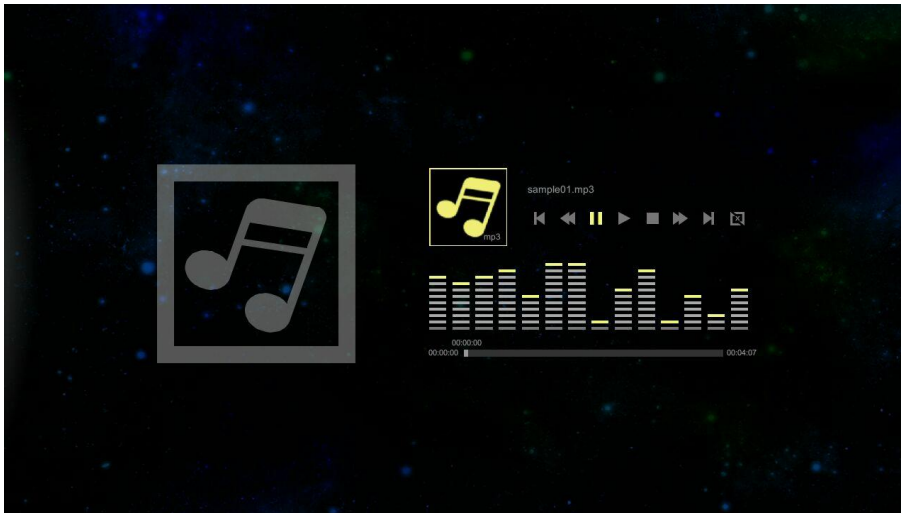

ITEM	DESCRIPTION
⏮	Previous file
⏪	Fast forward
⏸	Pause
▶	Play
■	Stop
⏩	Fast rewind
⏭	Next file
🔁	Repeat

## Office viewer

To open a file in document viewer, perform the following:

Press ▲ ▼ to select **Media** and then press ↵.

Press ▲ ▼ to select **Internal Memory** or **USB** and then press ↵.

Press ▲ ▼ to select **Office viewer** and then press ↵ to open file directory.

Select the folder containing the desired file.

Press ↵ to display.

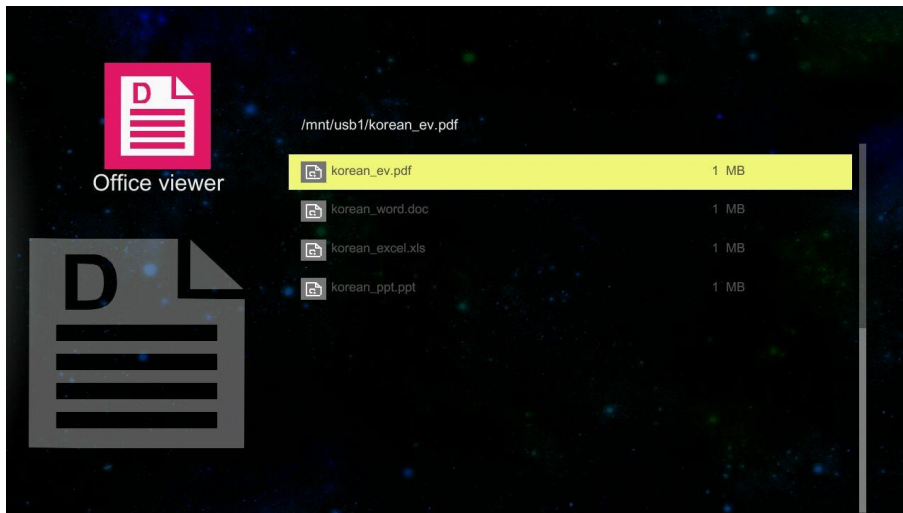

## SUPPORTED MEDIA SPECIFICATIONS

### Supported Photo Formats

IMAGE TYPE	SUB TYPE	ENCODE TYPE	MAX PIXELS
Jpeg Jpg	Baseline	YUV400 YUV420 YUV422 YUV440 YUV444	No limit
	Progressive	YUV400 YUV420 YUV422 YUV440 YUV444	Width <= 10240 & Height <= 6400
BMP			No limit

### Supported Music Formats

MUSIC TYPE	SAMPLE RATE (KBPS)	BIT RATE (KBPS)
MP1/MP2/MP3	8-48	8-320
WMA	22-48	5-320
OGG	8-48	64-320
ADPCM-WAV	8-48	32-384
PCM-WAV	8-48	128-1536
AAC	8-48	8-256

## Supported Movie Formats

FILE TYPE	VIDEO CODE	RESOLUTION	BIT RATE	FRAME RATE	AUDIO CODE	REMARK
AVI MKV	XVID MPEG-4 H.264 M-JPEG WMV3	1080P	20 Mbps	30 fps	AC3 DTS MPEG1/3 PCM ADPCM AAC	No support VC-1 AP. H.264 support less than 4 reference frames. No Support AC3-HD, DTS-HD.
TS	H.264	1080P	20 Mbps	30 fps	AC3 AAC MPEG1/3 DTS LPCM	H.264 support less than 4 reference frames. No Support AC3-HD, DTS-HD.
DAT VOD MPG MPEG	MPEG-1	1080P	20 Mbps	30 fps	MPEG-1/3 AC3 DTS LPCM	No Support AC3-HD, DTS-HD.
MOV MP4	MPEG-4 H.264	1080P	20 Mbps	30 fps	AAC AMR PCM ADPCM	H.264 support less than 4 reference frames.
WMV	WMV3	1080P	20 Mbps	30 fps	WMA2 WMA3	No Support VC-1 AP.

## Supported Document Formats

- Microsoft® Word (97-2007, .doc)
- Microsoft® PowerPoint (97-2007, .ppt)
- Microsoft® Excel (97-2007, .xls)
- Adobe® PDF (.pdf)
- Text (.txt)

## MAINTENANCE AND SECURITY

### Replacing the Projection Lamp

The projection lamp should be replaced when it burns out. It should only be replaced with a certified replacement part, which you can order from your local dealer.



**Important:**

- a. The projection lamp used in this product contains a small amount of mercury.
- b. Do not dispose this product with general household waste.
- c. Disposal of this product must be carried out in accordance with the regulations of your local authority.



**Warning:**

Be sure to turn off and unplug the projector at least 30 minutes before replacing the lamp. Failure to do so could result in a severe burn.



**Caution:**

In rare cases the lamp bulb may burn out during normal operation and cause glass dust or shards to be discharged outward from the rear exhaust vent.

Do not inhale or do not touch glass dust or shards. Doing so could result in injury.

Always keep your face away from the exhaust vent so that you do not suffer from the gas and broken shards of the lamp.

When removing the lamp from a ceiling-mounted projector, make sure that no one is under the projector. Glass fragments could fall if the lamp has been burned out.



**IF A LAMP EXPLODES**

If a lamp explodes, the gas and broken shards may scatter inside the projector and they may come out of the exhaust vent. The gas contains toxic mercury.

Open windows and doors for ventilation.

If you inhale the gas or the shards of the broken lamp enter your eyes or mouth, consult the doctor immediately.

1. Loosen the single screw on the lamp compartment cover.

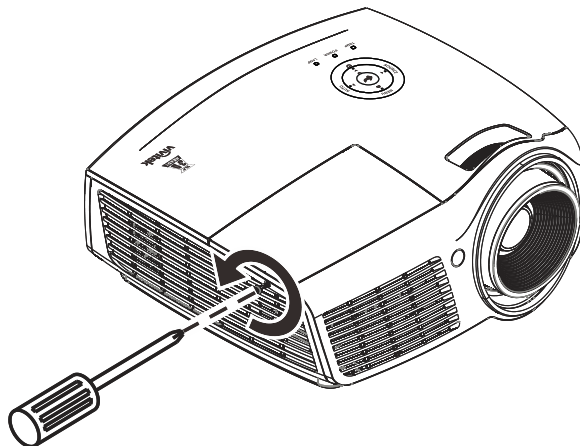



2. Remove the lamp compartment cover.

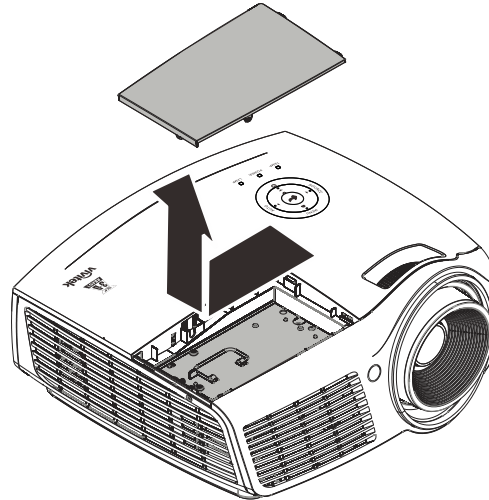

3. Remove the three screws from the lamp module.

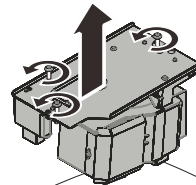

4. Lift the module handle up.

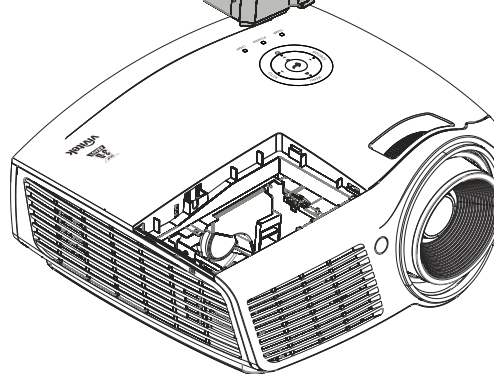

5. Pull firmly on the module handle to remove the lamp module.

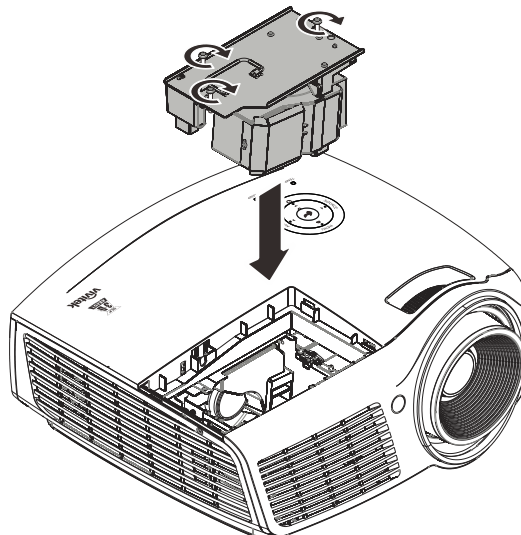

6. Reverse steps 1 to 5 to install the new lamp module. While installing, align the lamp module with the connector and ensure it is level to avoid damage.

**Note:** The lamp module must sit securely in place and the lamp connector must be connected properly before tightening the screws.

## Resetting the Lamp

After replacing the lamp, you should reset the lamp hour counter to zero. Refer to the following:

1. Press the **MENU** button to open the OSD menu.

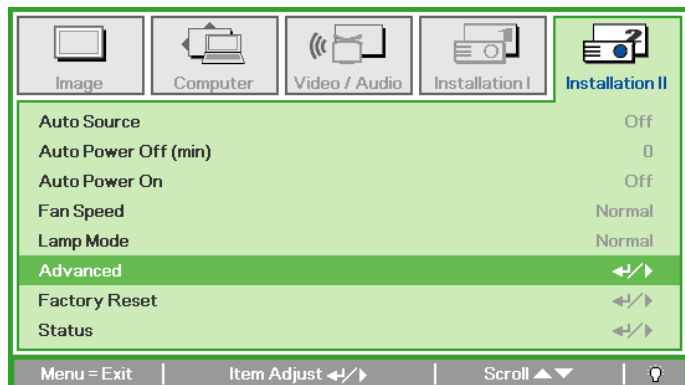

2. Press the cursor **◀▶** button to move to the **Installation II** menu. Press the cursor button to move down to **Advanced**.

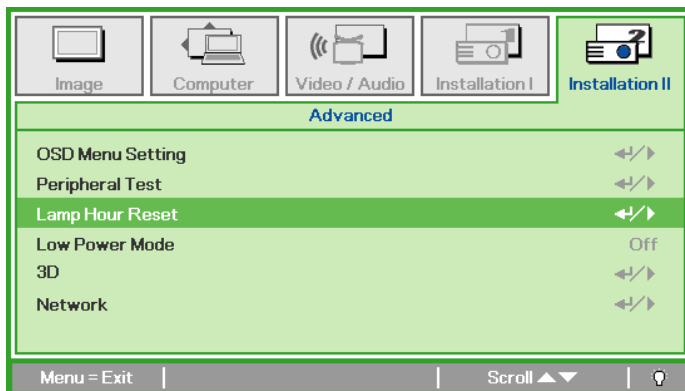

3. Press the cursor **▼▲** button to move down to **Lamp Hour Reset**.

4. Press the cursor **▶** or Enter button.

A message screen appears.

5. Press **▼▲◀▶** buttons to reset the lamp hour.

6. Press the **MENU** button to get back to Installation II.

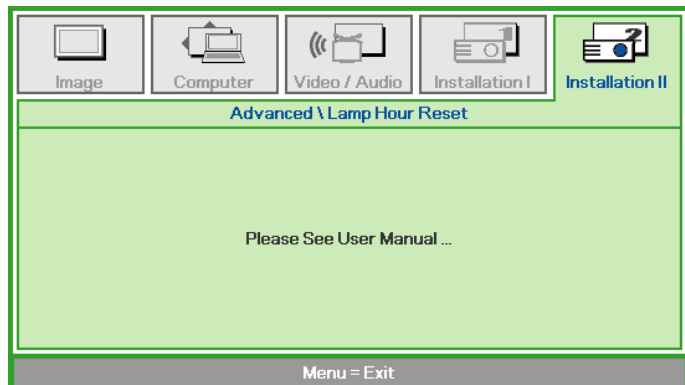

## **Cleaning the Projector**

Cleaning the projector to remove dust and grime will help ensure trouble-free operation.



**Warning:**

1. Be sure to turn off and unplug the projector at least 30 minutes before cleaning. Failure to do so could result in a severe burn.
2. Use only a dampened cloth when cleaning. Do not allow water to enter the ventilation openings on the projector.
3. If a little water gets into the projector interior while cleaning, leave unplugged in a well-ventilated room for several hours before using.
4. If a lot of water gets into the projector interior when cleaning, have the projector serviced.

### Cleaning the Lens

You can purchase optic lens cleaner from most camera stores. Refer to the following to clean the projector lens.

1. Apply a little optic lens cleaner to a clean soft cloth. (Do not apply the cleaner directly to the lens.)
2. Lightly wipe the lens in a circular motion.



**Caution:**

1. Do not use abrasive cleaners or solvents.
2. To prevent discoloration or fading, avoid getting cleaner on the projector case.

### Cleaning the Case

Refer to the following to clean the projector case.

1. Wipe off dust with a clean dampened cloth.
2. Moisten the cloth with warm water and mild detergent (such as used to wash dishes), and then wipe the case.
3. Rinse all detergent from the cloth and wipe the projector again.



**Caution:**

*To prevent discoloration or fading of the case, do not use abrasive alcohol-based cleaners.*

## Using the Kensington® Lock & Using the Security Bar

### Using the Kensington® Lock

If you are concerned about security, attach the projector to a permanent object with the Kensington slot and a security cable.

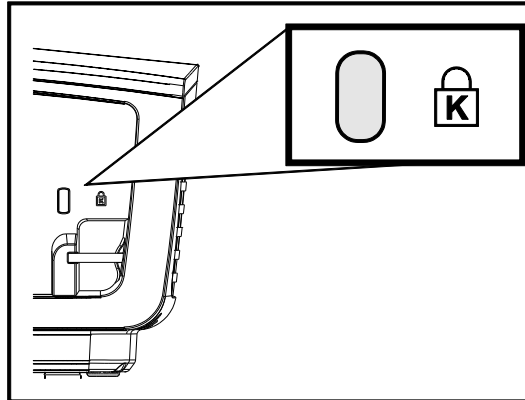

**Note:**

Contact your vendor for details on purchasing a suitable Kensington security cable. The security lock corresponds to Kensington's MicroSaver Security System. If you have any comment, contact: Kensington, 2853 Campus Drive, San Mateo, CA 94403, U.S.A. Tel: 800-535-4242, <http://www.Kensington.com>.

### Using the Security Bar

In addition to the password protection function and the Kensington lock, the Security Bar helps protect the projector from unauthorized removal. See the following picture.

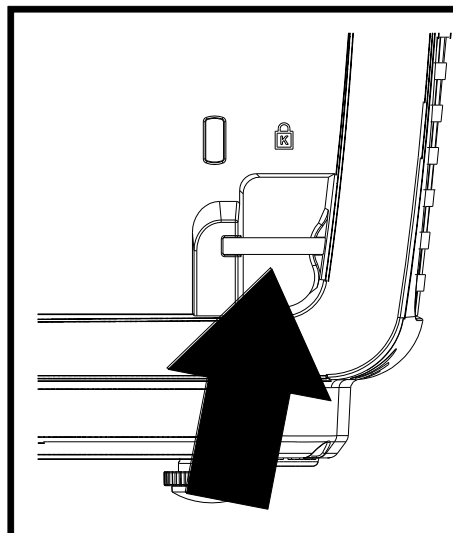

### Common problems and solutions

These guidelines provide tips to deal with problems you may encounter while using the projector. If the problem remains unsolved, contact your dealer for assistance.

Often after time spent troubleshooting, the problem is traced to something as simple as a loose connection. Check the following before proceeding to the problem-specific solutions.

- *Use some other electrical device to confirm that the electrical outlet is working.*
- *Ensure the projector is turned on.*
- *Ensure all connections are securely attached.*
- *Ensure the attached device is turned on.*
- *Ensure a connected PC is not in suspending mode.*
- *Ensure a connected notebook computer is configured for an external display.  
(This is usually done by pressing an Fn-key combination on the notebook.)*

### Tips for Troubleshooting

In each problem-specific section, try the steps in the order suggested. This may help you to solve the problem more quickly.

Try to pin point the problem and thus avoid replacing non-defective parts.

For example, if you replace batteries and the problem remains, put the original batteries back and go to the next step.

Keep a record of the steps you take when troubleshooting: The information may be useful when calling for technical support or for passing on to service personnel.

## LED Error Messages

ERROR CODE MESSAGES	POWER LED GREEN	LAMP LED RED	TEMP LED RED
Ready to power on (Standby)	ON	OFF	OFF
System Warm up	Flash	OFF	OFF
Lamp Lit , System stable	ON	OFF	OFF
Cooling	Flashing	OFF	OFF
Over Temperature	OFF	OFF	ON
Thermal Break Sensor error	4 blinks	OFF	OFF
Lamp Fail	OFF	ON	OFF
Lamp over voltage	5 blinks	1 blinks	OFF
Input voltage too high	5 blinks	2 blinks	OFF
Temp too high	5 blinks	3 blinks	OFF
Asymmetry detected	5 blinks	4 blinks	OFF
Lamp under voltage	5 blinks	5 blinks	OFF
Input voltage too low	5 blinks	6 blinks	OFF
Axial Fan error	6 blinks	1 blinks	OFF
Blower Fan error	6 blinks	2 blinks	OFF
DMD Fan error	6 blinks	3 blinks	OFF
Case Open	7 blinks	OFF	OFF
Color wheel error	9 blinks	OFF	OFF
Ballast communication error	10 blinks	1 blinks	OFF

In the event of an error, please disconnect the AC power cord and wait for one (1) minute before restarting the projector. If the Power or Lamp LEDs are still blinking or any other situation that isn't listed in the chart above, please contact your service center.

## Image Problems

### ***Problem: No image appears on the screen***

1. Verify the settings on your notebook or desktop PC.
2. Turn off all equipment and power up again in the correct order.

### ***Problem: The image is blurred***

1. Adjust the **Focus** on the projector.
2. Press the **Auto** button on the remote control.
3. Ensure the projector-to-screen distance is within the 10-meter (33-feet) specified range.
4. Check that the projector lens is clean.

### ***Problem: The image is wider at the top or bottom (trapezoid effect)***

1. Position the projector so it is as perpendicular to the screen as possible.
2. Use the **Keystone** button on the remote control to correct the problem.

***Problem: The image is reversed***

Check the **Projection** setting on the **Installation I** menu of the OSD.

***Problem: The image is streaked***

1. Set the **Frequency** and **Tracking** settings on the **Computer** menu of the OSD to the default settings.
2. To ensure the problem is not caused by a connected PC's video card, connect to another computer.

***Problem: The image is flat with no contrast***

Adjust the **Contrast** setting on the **Image** menu of the OSD.

***Problem: The color of the projected image does not match the source image.***

Adjust the **Color Temperature** and **Gamma** settings on the **Image** menu of the OSD.

## **Lamp Problems**

***Problem: There is no light from the projector***

1. Check that the power cable is securely connected.
2. Ensure the power source is good by testing with another electrical device.
3. Restart the projector in the correct order and check that the Power LED is on.
4. If you have replaced the lamp recently, try resetting the lamp connections.
5. Replace the lamp module.
6. Put the old lamp back in the projector and have the projector serviced.

***Problem: The lamp goes off***

1. Power surges can cause the lamp to turn off. Re-plug power cord. When the Power LED is on, press the power button.
2. Replace the lamp module.
3. Put the old lamp back in the projector and have the projector serviced.

## **Remote Control Problems**

***Problem: The projector does not respond to the remote control***

1. Direct the remote control towards remote sensor on the projector.
2. Ensure the path between remote and sensor is not obstructed.
3. Turn off any fluorescent lights in the room.
4. Check the battery polarity.
5. Replace the batteries.
6. Turn off other Infrared-enabled devices in the vicinity.
7. Have the remote control serviced.

## **Audio Problems**

### ***Problem: There is no sound***

1. Adjust the volume on the remote control.
2. Adjust the volume of the audio source.
3. Check the audio cable connection.
4. Test the source audio output with other speakers.
5. Have the projector serviced.

### ***Problem: The sound is distorted***

1. Check the audio cable connection.
2. Test the source audio output with other speakers.
3. Have the projector serviced.

## **Having the Projector Serviced**

If you are unable to solve the problem, you should have the projector serviced. Pack the projector in the original carton. Include a description of the problem and a checklist of the steps you took when trying to fix the problem: The information may be useful to service personnel. For servicing, return the projector to the place you purchased it.



## **HDMI Q & A**

***Q. What is the difference between a “Standard” HDMI cable and a “High-Speed” HDMI cable?***

Recently, HDMI Licensing, LLC announced that cables would be tested as Standard or High-Speed cables.

Standard (or “category 1”) HDMI cables have been tested to perform at speeds of 75Mhz or up to 2.25Gbps, which is the equivalent of a 720p/1080i signal.

High Speed (or “category 2”) HDMI cables have been tested to perform at speeds of 340Mhz or up to 10.2Gbps, which is the highest bandwidth currently available over an HDMI cable and can successfully handle 1080p signals including those at increased color depths and/or increased refresh rates from the Source. High-Speed cables are also able to accommodate higher resolution displays, such as WQXGA cinema monitors (resolution of 2560 x 1600).

***Q. How do I run HDMI cables longer than 10 meters?***

There are many HDMI Adapters working on HDMI solutions that extend a cable's effective distance from the typical 10 meter range to much longer lengths. These companies manufacture a variety of solutions that include active cables (active electronics built into cables that boost and extend the cable's signal), repeaters, amplifiers as well as CAT5/6 and fiber solutions.

***Q. How can I tell if a cable is an HDMI certified cable?***

All HDMI products are required to be certified by the manufacturer as part of the HDMI Compliance Test Specification. However, there may be instances where cables bearing the HDMI logo are available but have not been properly tested. HDMI Licensing, LLC actively investigates these instances to ensure that the HDMI trademark is properly used in the market. We recommend that consumers buy their cables from a reputable source and a company that is trusted.

For more detail information check <http://www.hdmi.org/learningcenter/faq.aspx#49>

## SPECIFICATIONS

## Specifications

Model	D863	DX864	DW866
Display type	TI DMD 0.55"		TI DMD 0.65"
Resolution	XGA 1024x768		WXGA, 1280x800
Projection distance	1 ~ 10 m		
Projection screen size	25.6" ~ 308"		27.1"- 302.2"
Projection lens	Manual Focus/Manual Zoom		
Zoom ratio	1.2x		1.1x
Vertical keystone correction	+/- 40 steps		
Projection methods	Front, Rear, Desktop/Ceiling (Rear, Front)		
Data compatibility	VGA, SVGA, XGA, SXGA, SXGA+, UXGA, WUXGA@60hz, Mac		
SDTV/EDTV/ HDTV	480i, 576i, 480p, 576p, 720p, 1080i, 1080p		
Video compatibility	NTSC (M, 3.58/4.43 MHz), PAL (B,D,G,H,I,M,N) SECAM (B,D,G,K,K1,L)		
H-Sync	15, 30 – 91.4 kHz		
V-Sync	43 – 87 Hz		
Safety certification	FCC-B, cUL, UL, CE, C-tick, CCC, KC, CB, EAC, NOM, SASO, PSB		
Operation temperature	5° ~ 40°C		
Dimensions	285 mm (W) x 261 mm (D) x 130 mm (H)		
AC Input	AC Universal 100-240V		
Power consumption	Normal : 250W, <0.5W(Stand By) / ECO : 210W, <0.5W(Standby)	Normal : 310W, <0.5W(Stand By) / ECO : 250W, <0.5W(Standby)	
Lamp	190W (Normal) / 160W (Eco)	240W (Normal) / 190W (Eco)	
Audio speaker	10W mono speaker		
Input Terminals	VGA x 2		
	Composite video x 1		
	PC Audio jack(3.5mm) x 1		
	USB type A x 1		
	USB type mini A/B x 1		
	HDMI x 1		
Output Terminals	RCA Stereo Audio LR x 1		
	VGA x 1		
Control Terminals	PC Audio jack(3.5mm) x 1		
	RS-232C		
	USB mini A x 1		
Security	RJ-45		
	Kensington lock / Security Bar		

**Note:** For questions regarding product specifications, please contact your local distributor.

## Projection Distance vs. Projection Size

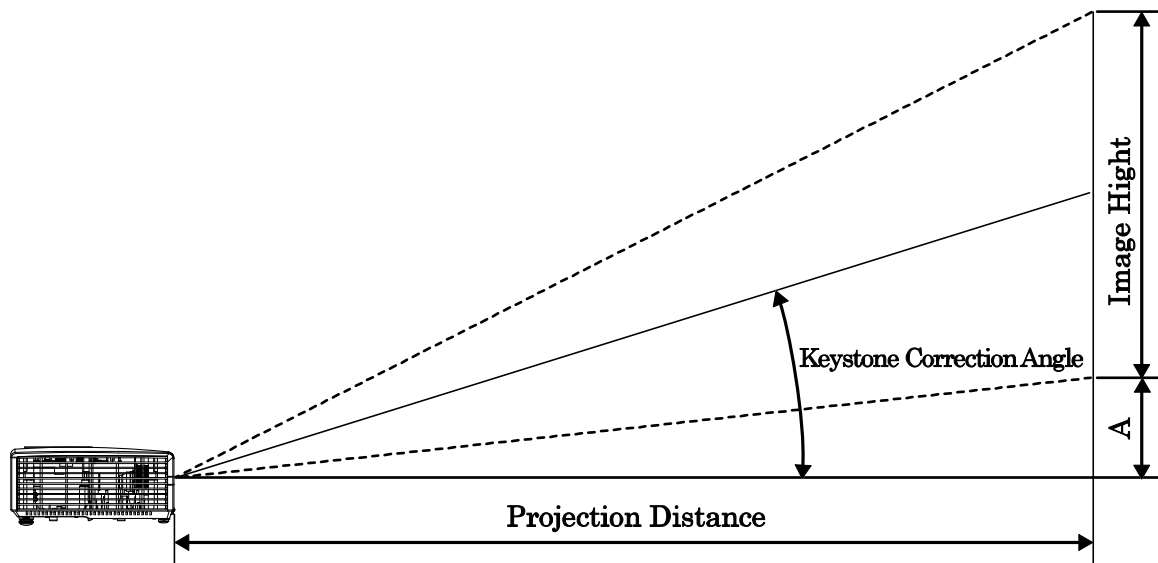

### Projection Distance and Size Table

XGA D863 / DX864

D863 / DX864									
IMAGE DIAGONAL	IMAGE WIDTH		IMAGE HEIGHT		PROJECTION DISTANCE FROM		PROJECTION DISTANCE TO		OFFSET-A
	(INCH)	(CM)	(INCH)	(CM)	(INCH)	(CM)	(INCH)	(CM)	
60	48	121.9	36	91.4	76.8	195.1	92.2	234.1	128
70	56	142.2	42	106.7	89.6	227.6	107.5	273.1	149.4
72	57.6	146.3	43.2	109.7	92.2	234.1	110.6	280.9	153.6
80	64	162.6	48	121.9	102.4	260.1	122.9	312.1	170.7
84	67.2	170.7	50.4	128	107.5	273.1	129.0	327.7	179.2
90	72	182.9	54	137.2	115.2	292.6	138.2	351.1	192
96	76.8	195.1	57.6	146.3	122.9	312.1	147.5	374.5	204.8
100	80	203.2	60	152.4	128.0	325.1	153.6	390.1	213.4
120	96	243.8	72	182.9	153.6	390.1	184.3	468.2	256
135	108	274.3	81	205.7	172.8	438.9	207.4	526.7	288
150	120	304.8	90	228.6	192.0	487.7	230.4	585.2	320
200	160	406.4	120	304.8	256.0	650.2	307.2	780.3	426.7

WXGA DW866

DW866									
IMAGE DIAGONAL	IMAGE WIDTH		IMAGE HIGHT		PROJECTION DISTANCE FROM		PROJECTION DISTANCE TO		OFFSET-A
( INCH )	( INCH )	( CM )	( INCH )	( CM )	( INCH )	( CM )	( INCH )	( CM )	( MM )
60	50.9	129.3	31.8	80.8	78.4	199.0	87.0	221.0	92.9
70	59.4	150.9	37.1	94.2	91.4	232.2	101.5	257.8	108.4
72	61.1	155.2	38.2	97	94.0	238.8	104.4	265.2	111.5
80	67.8	172.2	42.4	107.7	104.5	265.4	116.0	294.7	123.9
84	71.2	180.9	44.5	113	109.7	278.6	121.8	309.4	130.0
90	76.3	193.8	47.7	121.2	117.5	298.5	130.5	331.5	139.9
96	81.4	206.8	50.9	129.3	125.4	318.4	139.2	353.6	148.6
100	84.8	215.4	53	134.6	130.6	331.7	145.0	368.3	154.8
120	101.8	258.6	63.6	161.5	156.7	398.0	174.0	442.0	185.8
135	114.5	290.8	71.5	181.6	176.3	447.8	195.8	497.2	209.0
150	127.2	323.1	79.5	201.9	195.9	497.6	217.5	552.5	232.2
200	169.6	430.8	106	269.2	261.2	663.4	290.0	736.6	309.6

**Timing Mode Table**

SIGNAL	RESOLUTION	H-SYNC (KHz)	V-SYNC (Hz)	COMPOSITE / S-VIDEO	COMPONENT	RGB	DVI/ HDMI
NTSC	—	15.734	60.0	O	—	—	—
PAL/SECAM	—	15.625	50.0	O	—	—	—
VESA	720 x 400	37.9	85.0	—	—	O	O
	640 x 480	31.5	60.0	—	—	O	O
	640 x 480	37.9	72.0	—	—	O	O
	640 x 480	37.5	75.0	—	—	O	O
	640 x 480	43.3	85.0	—	—	O	O
	800 x 600	35.2	56.0	—	—	O	O
	800 x 600	37.9	60.0	—	—	O	O
	800 x 600	48.1	72.0	—	—	O	O
	800 x 600	46.9	75.0	—	—	O	O
	800 x 600	53.7	85.0	—	—	O	O
	1024 x 768	48.4	60.0	—	—	O	O
	1024 x 768	56.5	70.0	—	—	O	O
	1024 x 768	60.0	75.0	—	—	O	O
	1024 x 768	68.7	85.0	—	—	O	O
	1280 x 800	49.7	59.8	—	—	O	O
	1280 x 800	62.8	74.9	—	—	O	O
	1280 x 800	71.6	84.8	—	—	O	O
	1280 x 1024	63.98	60.0	—	—	O	O
	1280 x 1024	79.98	75.0	—	—	O	O
	1280 x 1024	91.10	85.0	—	—	O	O
	1280 x 960	60.0	60.0	—	—	O	O
	1280 x 960	85.9	85.0	—	—	O	O
	1400 x 1050	65.3	60.0	—	—	O	O
	1440 x 900	70.6	75.0	—	—	O	O
1440 x 900	55.6	60.0	—	—	O	O	
1600 x 1200	75.0	60.0	—	—	O	O	
Apple Mac	640 x 480	35.0	66.68	—	—	O	O

SIGNAL	RESOLUTION	H-SYNC (KHz)	V-SYNC (Hz)	COMPOSITE / S-VIDEO	COMPONENT	RGB	DVI/ HDMI
	832 x 624	49.725	74.55	—	—	O	O
	1024 x 768	60.24	75.0	—	—	O	O
	1152 x 870	68.68	75.06	—	—	O	O
SDTV	480i	15.734	60.0	—	O	—	O
	576i	15.625	50.0	—	O	—	O
EDTV	480p	31.469	60.0	—	O	—	O
	576p	31.25	50.0	—	O	—	O
HDTV	720p	37.5	50.0	—	O	—	O
	720p	45.0	60.0	—	O	—	O
	1080i	33.8	60.0	—	O	—	O
	1080i	28.1	50.0	—	O	—	O
	1080p	67.5	60.0	—	O	—	O
	1080p	56.3	50.0	—	O	—	O

O: Frequency supported

—: Frequency not supported

\* : Displayable level

## Projector Dimensions

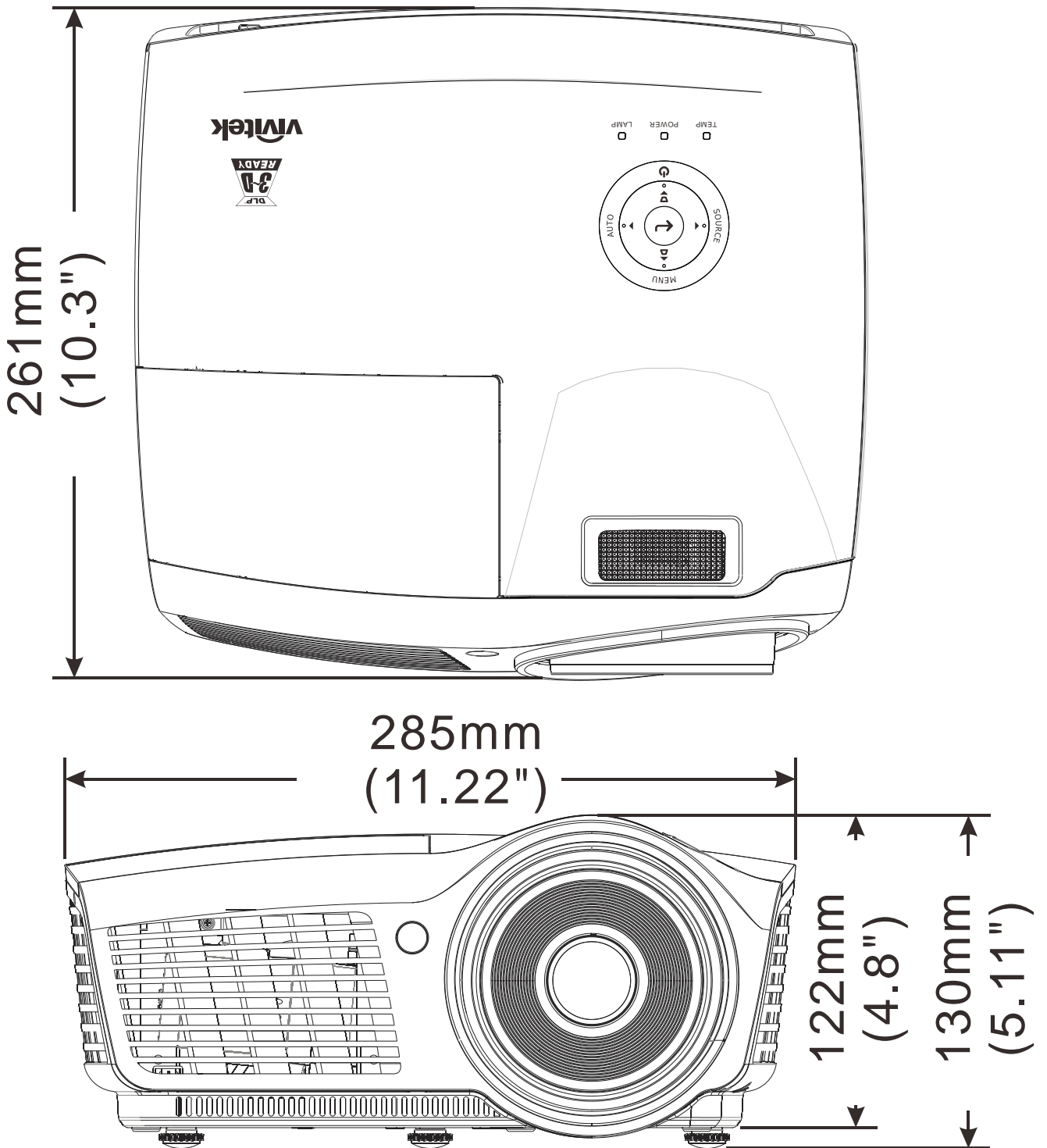

## **REGULATORY COMPLIANCE**

### **FCC Warning**

This equipment has been tested and found to comply with the limits for a Class B digital device pursuant to Part 15 of the FCC Rules. These limits are designed to provide reasonable protection against harmful interference when the equipment is operated in a commercial environment.

This equipment generates, uses, and can radiate radio frequency energy and, if not installed and used in accordance with the instruction manual, may cause harmful interference to radio communications. Operation of this equipment in a residential area is likely to cause harmful interference in which case the user will be required to correct the interference at his/her own expense.

Changes or modifications not expressly approved by the parties responsible for compliance could void the user's authority to operate the equipment.

### **Canada**

This class B digital apparatus complies with Canadian ICES-003.

### **Safety Certifications**

FCC-B, cUL, UL, CE, C-tick, CCC, KC, CB, EAC, NOM, SASO, PSB.



**RS-232C Protocol**

*RS232 Setting*

Baud rate:	<b>9600</b>
Parity check:	<b>None</b>
Data bit:	<b>8</b>
Stop bit:	<b>1</b>
Flow Control	<b>None</b>

Minimum delay for next command: **1ms**

*Control Command Structure*

**P1**

**P2**

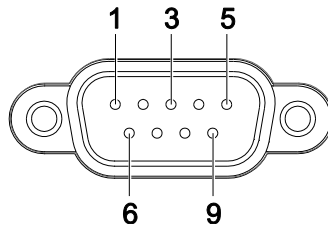
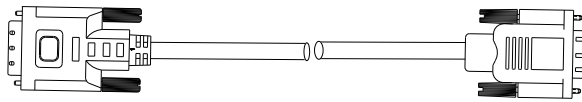

P1		P2
Pin no.	Name	Pin no.
1	NC	1
2	RXD	3
3	TXD	2
4	NC	4
5	GND	5
6	NC	6
7	RTS	7
8	CTS	8
9	NC	9

	Header code	Command code	Data code	End code
<b>HEX</b>		<b>Command</b>	<b>Data</b>	<b>0Dh</b>
<b>ASCII</b>	<b>'V'</b>	<b>Command</b>	<b>Data</b>	<b>CR</b>

*Operation Command*

Note:  
 "CR" mean Carriage Return  
 XX=00-98, projector's ID, XX=99 is for all projectors  
 Return Result P=Pass / F=Fail  
 n: 0:Disable/1: Enable/Value(0~9999)

<b>Command Group 00</b>			
<b>ASCII</b>	<b>Function</b>	<b>Description</b>	<b>Return Result</b>
VXXS0001	Power On		P/F
VXXS0002	Power Off		P/F
VXXS0003	Resync		P/F
VXXG0004	Get Lamp Hours		Pn/F
VXXS0005n	Set Air filter timer	n=0~999999	P/F
VXXG0005	Get Air filter timer	n=0~999999	Pn/F
VXXS0006	System Reset		P/F
VXXG0007	Get System Status	0: Standby 2:Operation 3:Cooling	Pn/F
VXXG0008	Get F/W Version		Pn/F
VXXG0009	Get Alter EMail		Pn/F
VXXS0009n	Set Alter Email	<u>n=xxxxxx@xxxx.xxx.x</u> x	P/F

<b>Command Group 01</b>			
<b>ASCII</b>	<b>Function</b>	<b>Description</b>	<b>Return Value</b>
VXXG0101	Get Brightness	n=0~100	Pn/F
VXXS0101n	Set Brightness	n=0~100	P/F
VXXG0102	Get Contrast	n=0~100	Pn/F
VXXS0102n	Set Contrast	n=0~100	P/F
VXXG0103	Get Color	n=0~100	Pn/F
VXXS0103n	Set Color	n=0~100	P/F
VXXG0104	Get Tint	n=0~100	Pn/F
VXXS0104n	Set Tint	n=0~100	P/F
VXXG0105	Get Sharpness	0~31	Pn/F
VXXS0105n	Set Sharpness	0~31	P/F
VXXG0106	Get Color Temperature	0:Cold 1:Normal 2:Warm	Pn/F
VXXS0106n	Set Color Temperature	0:Cold 1:Normal 2:Warm	P/F

VXXG0107	Get Gamma	0:PC 1:MAC 2:Video 3:Chart 4: B&W	Pn/F
VXXS0107n	Set Gamma	0:PC 1:MAC 2:Video 3:Chart 4: B&W	P/F

**Command Group 02**

ASCII	Function	Description	Return Value
VXXS0201	Select RGB		P/F
VXXS0202	Select RGB2		P/F
VXXS0203	Select DVI		P/F
VXXS0204	Select Video		P/F
VXXS0205	Select S-Video		P/F
VXXS0206	Select HDMI		P/F
VXXS0207	Select BNC		P/F
VXXS0208	Select Component		P/F
VXXS0209	Select HDMI 2		P/F
VXXG0220	Get Current Source	Return 1:RGB 2:RGB2 3:DVI 4:Video 5:S-Video 6:HDMI 7:BNC 8:Component 9:HDMI 2	Pn/F

**Command Group 03**

ASCII	Function	Description	Return Value
VXXG0301	Get Scaling	0: Fill 1: 4:3 2: 16:9 3 :Letter Box 4 :Native	Pn/F
VXXS0301n	Set Scaling	0: Fill 1: 4:3 2: 16:9 3 :Letter Box 4 :Native	P/F
VXXG0302	Blank		Pn/F
VXXS0302n	Blank		P/F
VXXG0303	Auto Keystone On		Pn/F

VXXS0303n	Auto Keystone On		P/F
VXXG0304	Freeze On		Pn/F
VXXS0304n	Freeze On		P/F
VXXG0305	Volume	n=0~8	Pn/F
VXXS0305n	Volume	n=0~8	P/F
VXXG0306	Treble	n=0~16	Pn/F
VXXS0306n	Treble	n=0~16	P/F
VXXG0307	Bass	n=0~16	Pn/F
VXXS0307n	Bass	n=0~16	P/F
VXXG0308	Projection Mode	0:Front 1:Rear 2:Ceiling 3:Rear+Ceiling	Pn/F
VXXS0308n	Projection Mode	0:Front 1:Rear 2:Ceiling 3:Rear+Ceiling	P/F
VXXG0309	Get vertical keystone value	n= -40~40	Pn/F
VXXS0309n	Set vertical keystone value	n= -40~40	P/F
VXXG0311	Adjust the zoom	n=-10~10	Pn/F
VXXS0311n	Adjust the zoom	n=-10~10	P/F

#### Command Group 04 (Remote Control)

ASCII	Function	Description	Return Value
VXXS0401	UP arrow		P/F
VXXS0402	DOWN arrow		P/F
VXXS0403	LEFT arrow		P/F
VXXS0404	RIGHT arrow		P/F
VXXS0405	POWER		P/F
VXXS0406	EXIT		P/F
VXXS0407	INPUT		P/F
VXXS0408	AUTO		P/F
VXXS0409	KEYSTONE+		P/F
VXXS0410	KEYSTONE-		P/F
VXXS0411	MENU		P/F
VXXS0412	STATUS		P/F
VXXS0413	MUTE		P/F
VXXS0414	ZOOM+		P/F
VXXS0415	ZOOM-		P/F
VXXS0416	BLANK		P/F
VXXS0417	FREEZE		P/F
VXXS0418	VOLUME+		P/F
VXXS0419	VOLUME-		P/F
VXXS0420	Enter		P/F